

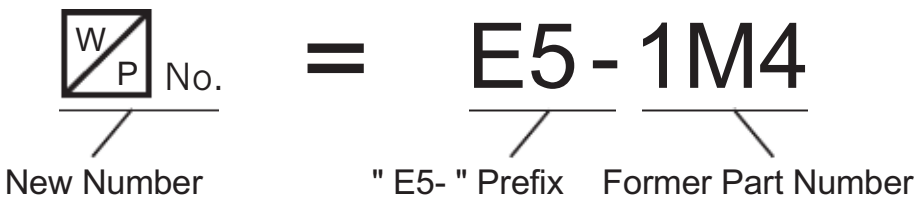

NOTE: Electrode and related items part numbers are now " E5- " followed by the former number.

Example:



Type 1M

Insulator length	W/P No.
4"	E5-1M4
4-1/4"	E5-1M4-1/4
4-1/2"	E5-1M4-1/2
5"	E5-1M5
6"	E5-1M6
7"	E5-1M7
8"	E5-1M8

Type 2M

Insulator length	W/P No.
4"	E5-2M4
4-1/2"	E5-2M4-1/2
5"	E5-2M5
5-1/2"	E5-2M5-1/2
6"	E5-2M6
7"	E5-2M7
8"	E5-2M8

Type 3M

Insulator length	W/P No.
4"	E5-3M4
4-1/2"	E5-3M4-1/2
5"	E5-3M5
5-1/2"	E5-3M5-1/2
6"	E5-3M6
7"	E5-3M7
8"	E5-3M8

Type 4M

Insulator length	W/P No.
4"	E5-4M4
4-1/4"	E5-4M4-1/4
4-1/2"	E5-4M4-1/2
5"	E5-4M5
6"	E5-4M6
7"	E5-4M7
8"	E5-4M8

Type 5M

Insulator length	W/P No.
4"	E5-5M4
5"	E5-5M5
6"	E5-5M6

Type 2F

Insulator length	W/P No.
4"	E5-2F4
4-1/2"	E5-2F4-1/2
5"	E5-2F5
5-1/2"	E5-2F5-1/2
6"	E5-2F6
7"	E5-2F7
8"	E5-2F8

Type 3F

Insulator length	W/P No.
4"	E5-3F4
4-1/2"	E5-3F4-1/2
5"	E5-3F5
5-1/2"	E5-3F5-1/2
6"	E5-3F6
7"	E5-3F7
8"	E5-3F8

Note: To order the insulator only for any electrode found on this page, add "INS" to the part number.

Westwood electrodes & insulators

HIGH DIELECTRIC STRENGTH • PRECISION DIMENSIONS

<p>Acc 5" B5-100 Acc 6" B5-100B Acc 7" B5-100C</p>	<p>Arco B5-124</p>	<p>ABC 6" B5-144A ABC 5" B5-144B ABC 4-1/2" B5-144C ABC 4" B5-144D ABC 3" B5-144E ABC 2" B5-144F ABC 1-3/4" B5-144G ABC None B5-144H</p>
<p>Acc B5-100A</p>	<p>Arco B5-126</p>	<p>ABC B5-146</p>
<p>Acc B5-102A</p>	<p>Arco B5-127</p>	<p>Arco B5-127A</p>
<p>Acc B5-102B</p>	<p>Armstrong B5-128</p>	<p>ABC 4-1/4" B5-146A ABC none B5-146B ABC 4-1/2" B5-146C</p>
<p>Acc B5-107</p>	<p>ABC (with bracket) B5-130</p>	<p>ABC B5-147</p>
<p>Aeroil B5-108</p>	<p>ABC (with bracket) B5-130A</p>	<p>ABC B5-148</p>
<p>Aero B5-109</p>	<p>ABC B5-148A</p>	<p>ABC B5-148B</p>
<p>Aero B5-110</p>	<p>Aero B5-110B</p>	<p>ABC B5-148C</p>
<p>Alcoa B5-111</p>	<p>ABC 4" B5-131A ABC 5" B5-132A</p>	<p>ABC B5-148D</p>
<p>Aero none B5-111A Aero 9-1/2" B5-111D Aero 13-1/2" B5-111E Aero 4-3/4" B5-111F Aero 7-1/2" B5-111G</p>	<p>ABC 4" B5-131 ABC 5" B5-132</p>	<p>ABC B5-148E</p>
<p>Arco B5-121</p>	<p>ABC B5-133</p>	<p>ABC B5-148F</p>
<p>Arco B5-122</p>	<p>ABC B5-148H</p>	<p>ABC B5-148J</p>
<p>Arco B5-123</p>	<p>ABC with 6" spring B5-148K</p>	<p>ABC with 6" spring B5-148K</p>

Please order by No.











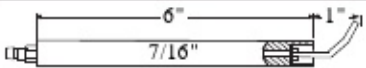
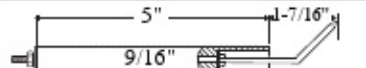
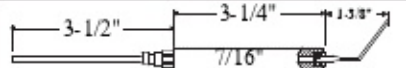
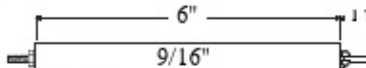
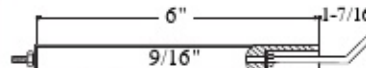
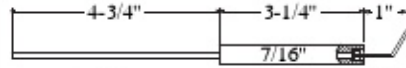
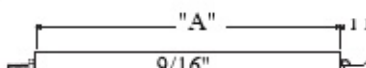
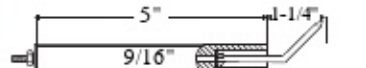
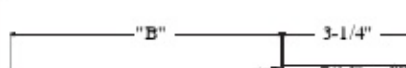
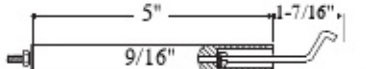
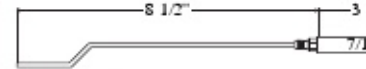
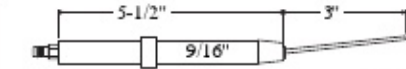
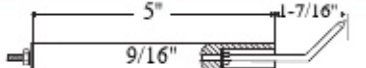
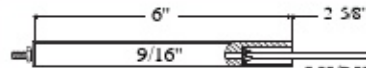
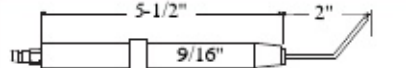
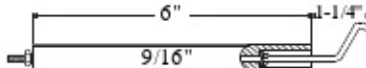
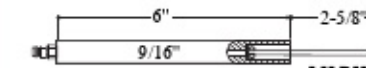

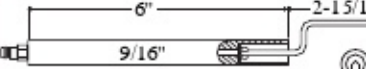
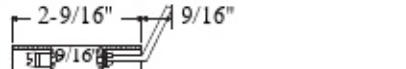

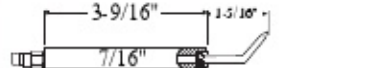
Westwood electrodes & insulators

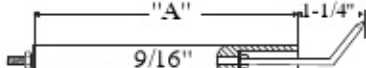
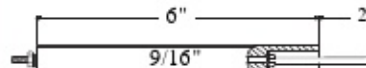
HIGH DIELECTRIC STRENGTH • PRECISION DIMENSIONS

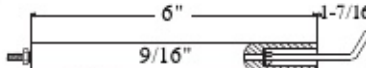
<p>ABC E5-148M</p>	<p>Beckett E5-151L</p>	<p>Beckett AF II HLX E5-151Z</p>
<p>ABC Sunray OE-1 E5-148Q</p>	<p>Beckett E5-151M</p>	<p>Beckett AF 15 E5-152B</p>
<p>ABC Sunray "A" "B" "C" E5-148R ABC Sunray 7/16" 3-1/4" 3/4" E5-148R1 ABC Sunray 7/16" 4-1/4" 1/4" E5-148R1 ABC Sunray 15/16" 3-1/4" 3/4" E5-148S</p>	<p>Beckett E5-151N</p>	<p>Beckett AF II FBX E5-152C</p>
<p>Beckett E5-151A</p>	<p>Beckett E5-151O</p>	<p>Bethlehem E5-156</p>
<p>Beckett E5-151B</p>	<p>Beckett "A" E5-151P Beckett 5" E5-151P1 Beckett 2" E5-151P2 Beckett 3/4" E5-151P2</p>	<p>Bettendorf E5-157</p>
<p>Beckett E5-151C</p>	<p>Beckett E5-151Q Beckett (without spring) E5-151Q1</p>	<p>Bettendorf E5-160</p>
<p>Beckett E5-151D</p>	<p>Beckett "A" E5-151R Beckett 2-7/16" E5-151R-1 Beckett 5" E5-151R-2 Beckett 3" E5-151R-3 Beckett none E5-151R-4 Beckett 6-3/4" E5-151R-4</p>	<p>Bettendorf E5-160A</p>
<p>Beckett E5-151E</p>	<p>Beckett E5-151E1</p>	<p>Bettendorf E5-160B</p>
<p>Beckett E5-151F</p>	<p>Beckett "A" E5-151S Beckett 6-3/4" E5-151T Beckett 13-3/4" E5-151T</p>	<p>Bettendorf E5-160C</p>
<p>Beckett E5-151G</p>	<p>Beckett E5-151U</p>	<p>Bettendorf E5-160E</p>
<p>Beckett E5-151H</p>	<p>Beckett E5-151V</p>	<p>Bettendorf E5-160G</p>
<p>Beckett E5-151I</p>	<p>Beckett "A" E5-151 Beckett 1-1/4" E5-152 Beckett 3-1/4" E5-152A Beckett 5" E5-153 Beckett 6-1/4" E5-153A Beckett 1-1/2" E5-153A</p>	<p>Bluegray E5-1880</p>
<p>Beckett E5-151J</p>	<p>Beckett E5-161B</p>	<p>Bock E5-161B</p>
<p>Beckett E5-151K</p>	<p>Beckett E5-151X</p>	<p>Bock E5-161C</p>

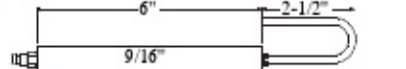
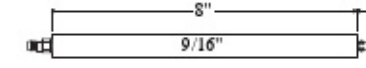
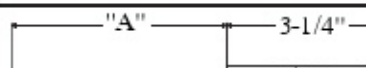
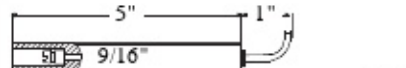
Westwood electrodes & insulators

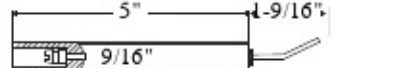
HIGH DIELECTRIC STRENGTH • PRECISION DIMENSIONS

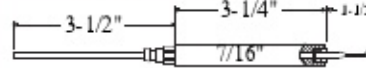
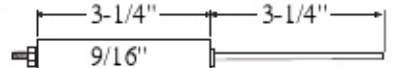
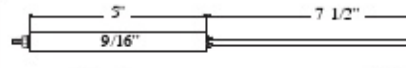
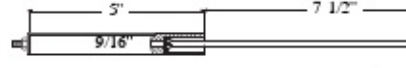
 Branford B5-170	 Carlin B5-188D	 Carlin B5-188P
 Carlin B5-184	 Carlin B5-188E	 Carlin B5-188Q
 Carlin "A" 4" B5-184A 5" B5-184B 6" B5-184C	 Carlin B5-188F	 Carlin "A" 7/8" "B" 12" B5-188R2 Carlin 1-9/16" 12" B5-188R3 Carlin 7/8" 15" B5-188R4
 Carlin B5-185	 Carlin B5-188H	 Century B5-189
 Carlin B5-185A	 Carlin LH/RH B5-188I	 Century B5-190
 Carlin B5-186	 Carlin LH/RH B5-188J	 Century B5-191
 Carlin B5-187	 Carlin B5-188K	 Century B5-191A
 Carlin B5-187A	 Carlin B5-188L	 Century B5-191B
 Carlin "A" 5" B5-187B 6" B5-187C	 Carlin B5-188M	 Chief B5-192
 Carlin B5-188	 Carlin "A" 7/8" B5-188N 1-9/16" B5-188N2	 Chief B5-192B
 Carlin B5-188A	 Carlin "A" 2-1/2" Heavy Tip B5-188N1 11" B5-188N3 1-1/2" B5-188N5 8-1/2" B5-188N6 4-1/2" B5-188N8 6-1/2" B5-188N9	 Chrysler B5-193
 Carlin "A" 7/8" B5-188B 1-9/16" B5-188B2	 Carlin "A" 8-1/2" Light Tip B5-188N4 4-1/2" B5-188N7 6-1/2" B5-188N10	 Chrysler B5-195
 Carlin B5-188C	 Carlin B5-188O	 Clayton B5-198
		 Clayton B5-199
		 Clayton B5-199A

Please order by  No.

Westwood electrodes & insulators

HIGH DIELECTRIC STRENGTH • PRECISION DIMENSIONS

 Clayton B5-199C	 Cleaver Brooks	 Columbia Boiler B5-207
 Clayton B5-199D	B5-205F 21 B5-205J 24 B5-205O 12 B5-205G 18-1/4 B5-205K 27 B5-205Q 30 B5-205H 19-3/4 B5-205L 14 B5-205I 15-3/4 B5-205M 27-1/2	 Columbia Boiler B5-207A
 Cleanburn B5-199Z	 Cleaver Brooks B5-205N	 Crane Crane "A" none 6" B5-213 B5-214
 Cleanburn B5-199Z1	 Cleaver Brooks B5-205R	 Delco B5-220
 Cleaver Brooks B5-201	 Cleaver Brooks B5-205U	 Delco B5-221
 Cleaver Brooks B5-203	 Cleaver Brooks B5-205V	 Delco B5-224
 Cleaver Brooks B5-204A	 Cleaver Brooks B5-205W	 Delco B5-225
 Cleaver Brooks B5-205	 Cleaver Brooks B5-205X	 Delco B5-226
 Cleaver Brooks B5-205A	 Cleaver Brooks B5-205Y	 Delco B5-227
Cleaver Brooks "A" 3" B5-205A Cleaver Brooks 4-3/4" B5-205A5	 Cleaver Brooks B5-205Z	 Delco B5-228
 Cleaver Brooks B5-205A1	 Cleaver Brooks B5-205Z2	 Delco B5-231
 Cleaver Brooks B5-205A2	 Cleaver Brooks B5-205Z3	 Dravo B5-232
 Cleaver Brooks B5-205B	 Coleman B5-202A	 Dravo B5-232A
 Cleaver Brooks B5-205D	 Coleman B5-202B	 Dravo B5-232B
Cleaver Brooks "A" 27-1/4" B5-205D Cleaver Brooks 16-1/2" B5-205E Cleaver Brooks 21-1/2" B5-205E2	 Columbia Boiler B5-206	 Dravo B5-232C

Westwood electrodes & insulators

HIGH DIELECTRIC STRENGTH • PRECISION DIMENSIONS

 Dravo B5-232D	 Ducane OilMaster™ B5-234L Ducane OilMaster™ B5-234M	 Electromagic B5-249A
 Dravo B5-232E	 Eclipse B5-234L Eclipse B5-234M	 Enterprise B5-253
 Dravo B5-232F	 Eclipse B5-235 Eclipse B5-235A Eclipse B5-235B	 Enterprise B5-253B Enterprise B5-253C Enterprise B5-253D
 Dravo B5-232G	 Eclipse B5-236	 Eroc B5-254
 Dravo B5-232H	 Eclipse B5-238	 Eroc B5-257
 Dravo B5-232I	 Eclipse B5-238B	 Esso B5-258
 Dravo B5-232J	 Economite B5-239	 Esso B5-259
 Dravo B5-232L	 Economite B5-239A	 Esso B5-259A
 Dravo B5-232M	 Economite B5-239B	 Esso B5-261
 Dravo B5-232N	 Economite B5-239C	 Flame Guard B5-267A Flame Guard B5-267B Flame Guard B5-267C Flame Guard B5-267E Flame Guard B5-267F Flame Guard B5-267G
 Dravo B5-233	 Economite B5-239D	 Flame Guard B5-267D
 Dravo B5-234	 Economite B5-239E	 Fluid Heat B5-273
 Dravo B5-234A Dravo B5-234B Dravo B5-234C Dravo B5-234D	 Economite B5-239F	 Fluid Heat B5-274
 Dravo B5-234E Dravo B5-234F Dravo B5-234G Dravo B5-234H Dravo B5-234I Dravo B5-234J	 Edison B5-246	 Fluid Heat B5-275
	 Edison B5-247	

Please order by No.





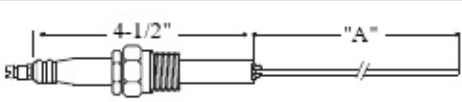
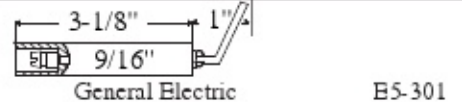
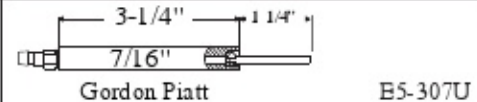
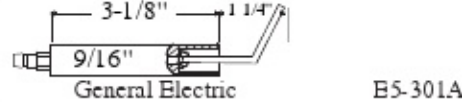
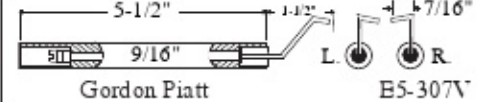
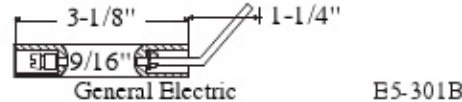
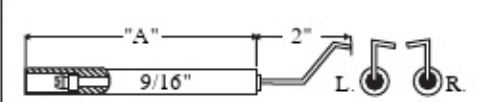
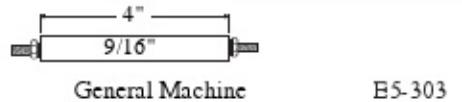
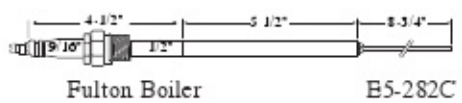
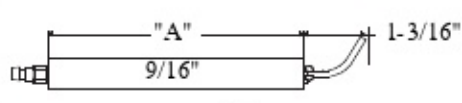
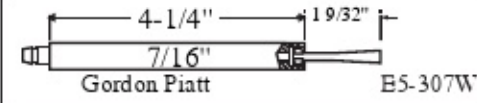
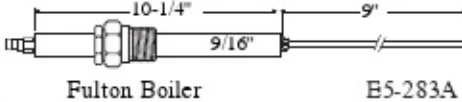
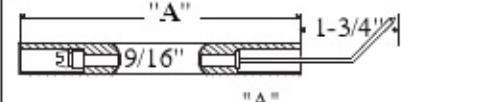
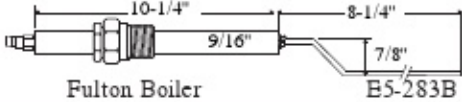
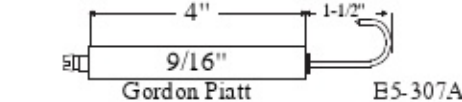
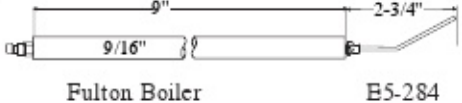
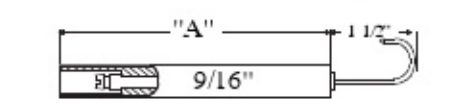
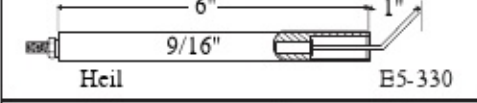
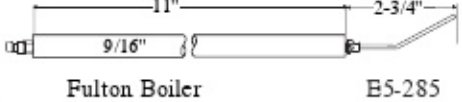
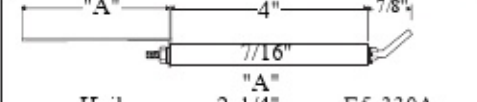
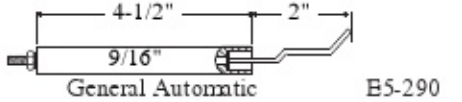
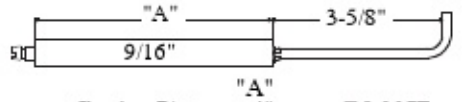
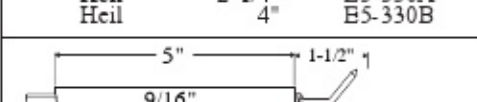
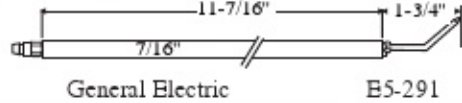
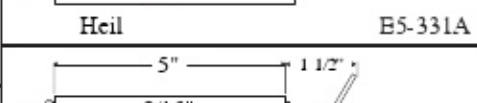
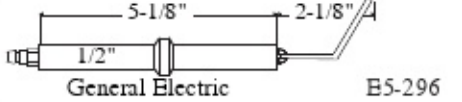
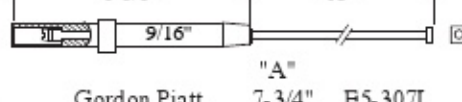
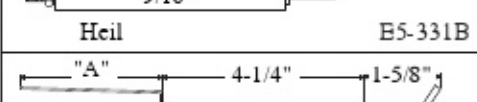
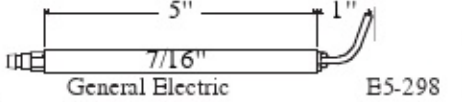
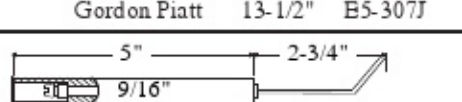
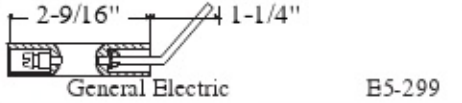
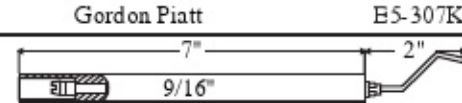
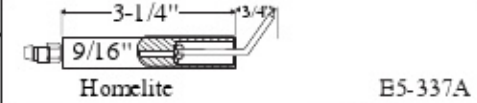
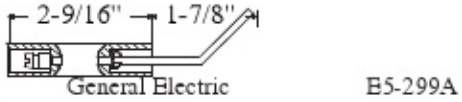
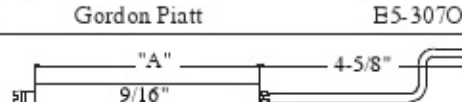
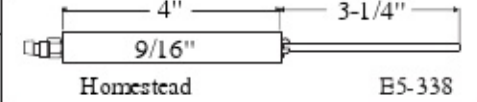
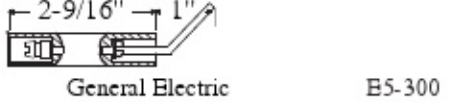
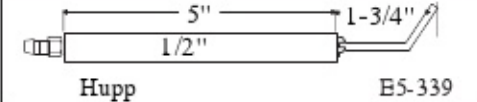





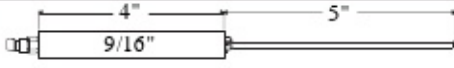

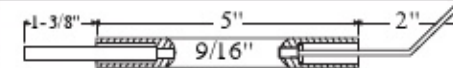
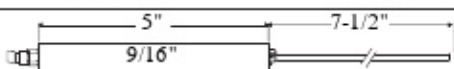

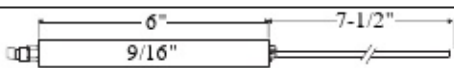
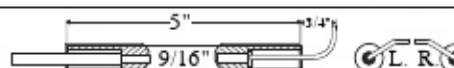
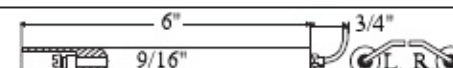
Westwood electrodes & insulators

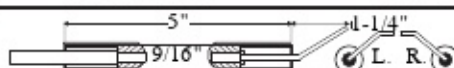
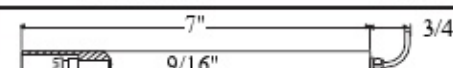
HIGH DIELECTRIC STRENGTH • PRECISION DIMENSIONS

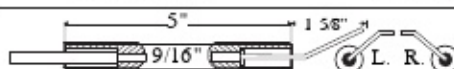
 <p>Fulton Boiler 12-1/4" E5-282 Fulton Boiler 17-1/4" E5-283</p>	 <p>General Electric E5-301</p>	 <p>Gordon Piatt E5-307U</p>
	 <p>General Electric E5-301A</p>	 <p>Gordon Piatt E5-307V</p>
	 <p>General Electric E5-301B</p>	 <p>Gordon Piatt E5-307N Gordon Piatt E5-307T</p>
	 <p>General Machine E5-303</p>	
 <p>Fulton Boiler E5-282C</p>	 <p>Gold Star 4" E5-306 Gold Star 5" E5-307</p>	 <p>Gordon Piatt E5-307W</p>
 <p>Fulton Boiler E5-283A</p>		 <p>Gould 5" E5-308 Gould 6" E5-309 Gould 7" E5-310 Gould 8" E5-311</p>
 <p>Fulton Boiler E5-283B</p>	 <p>Gordon Piatt E5-307A</p>	
 <p>Fulton Boiler E5-284</p>	 <p>Gordon Piatt 5" E5-307B Gordon Piatt 7" E5-307C Gordon Piatt 9" E5-307D</p>	 <p>Heil E5-330</p>
 <p>Fulton Boiler E5-285</p>		 <p>Heil 2-1/4" E5-330A Heil 4" E5-330B</p>
 <p>General Automatic E5-290</p>	 <p>Gordon Piatt 4" E5-307F Gordon Piatt 5" E5-307P Gordon Piatt 6" E5-307G Gordon Piatt 8" E5-307H</p>	 <p>Heil E5-331A</p>
 <p>General Electric E5-291</p>		 <p>Heil E5-331B</p>
 <p>General Electric E5-296</p>	 <p>Gordon Piatt 7-3/4" E5-307I Gordon Piatt 13-1/2" E5-307J</p>	 <p>Heil 1-1/4" E5-331C Heil 3" E5-331D</p>
 <p>General Electric E5-298</p>	 <p>Gordon Piatt E5-307K</p>	
 <p>General Electric E5-299</p>	 <p>Gordon Piatt E5-307O</p>	 <p>Honzelite E5-337A</p>
 <p>General Electric E5-299A</p>	 <p>Gordon Piatt 4" E5-307Q Gordon Piatt 6" E5-307R Gordon Piatt 8" E5-307S</p>	 <p>Homestead E5-338</p>
 <p>General Electric E5-300</p>		 <p>Hupp E5-339</p>

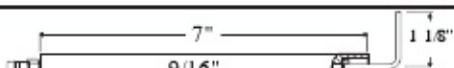
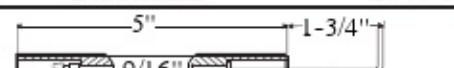
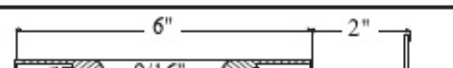
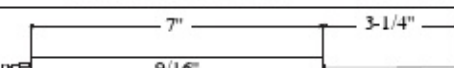
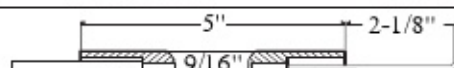
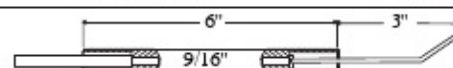
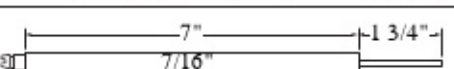
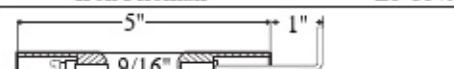
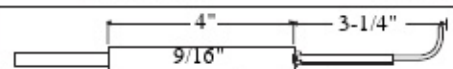
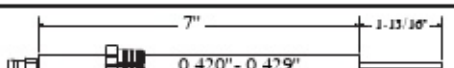
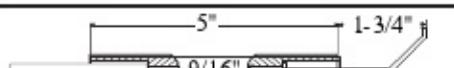
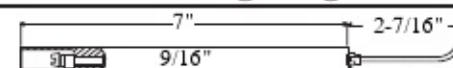
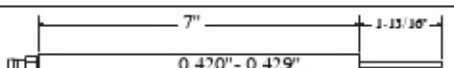
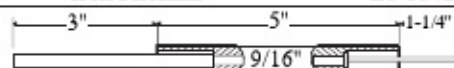
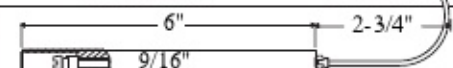
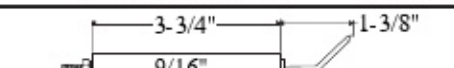
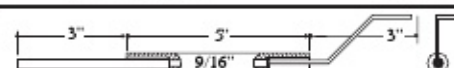
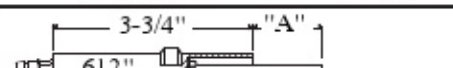
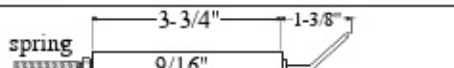
Westwood electrodes & insulators

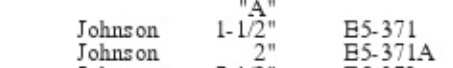
HIGH DIELECTRIC STRENGTH • PRECISION DIMENSIONS

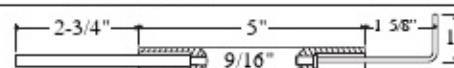
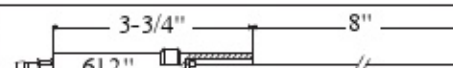
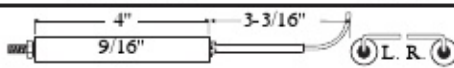
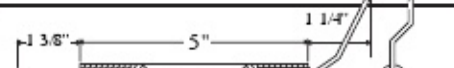
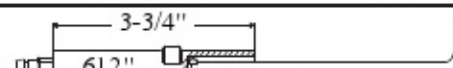
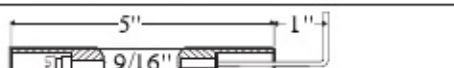
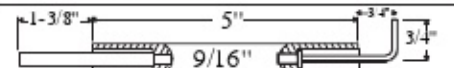
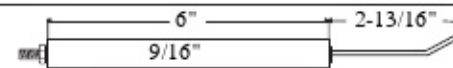
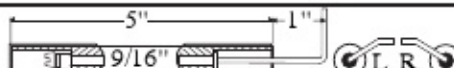
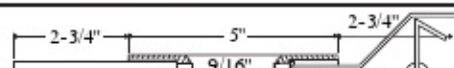
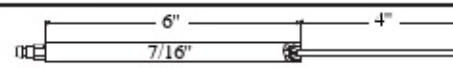
 Homestead B5-340	 Iron Fireman B5-357B	 Iron Fireman B5-357Y
 Homestead B5-341	 Iron Fireman B5-357C	 Iron Fireman B5-358
 Homestead B5-341A	 Iron Fireman B5-357D	 Iron Fireman B5-363
 Industrial Combustion B5-342	 Iron Fireman B5-357E	 Iron Fireman B5-364
 Industrial Combustion B5-343	 Iron Fireman B5-357F	 Iron Fireman B5-365
 Industrial Combustion B5-343A	 Iron Fireman B5-357I	 Iron Fireman B5-365B
 Industrial Combustion B5-344	 Iron Fireman B5-357J	 Iron Fireman B5-365D
 Industrial Combustion B5-344A	 Iron Fireman B5-357K	 Iron Fireman B5-366
 Industrial Combustion B5-345	 Iron Fireman B5-357L	 Iron Fireman B5-366A
 Industrial Combustion B5-345A	 Iron Fireman B5-357M	 Iron Fireman B5-366D
 International B5-348	 Iron Fireman B5-357N	 Johnson B5-371
 International B5-348A	 Iron Fireman B5-357O	 Johnson B5-371A
 International B5-349	 Iron Fireman B5-357R	 Johnson B5-372
 Iron Fireman B5-356	 Iron Fireman B5-357S	 Johnson B5-373A
 Iron Fireman B5-357	 Iron Fireman B5-357U	 Johnson B5-375
 Iron Fireman B5-357A	 Iron Fireman B5-357W	 Johnson B5-375A

Please order by  No.



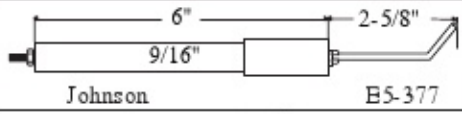
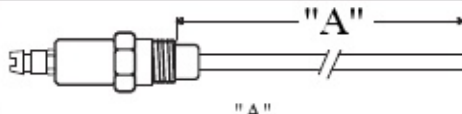
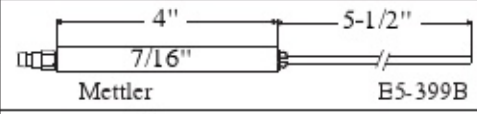
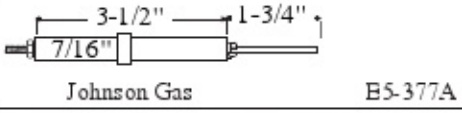
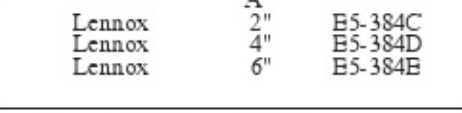
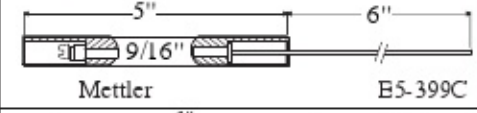
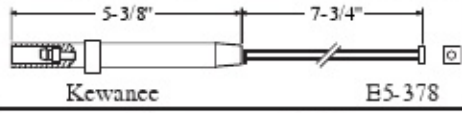
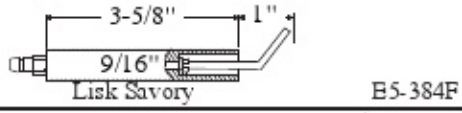
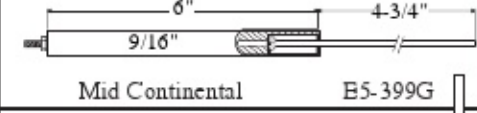
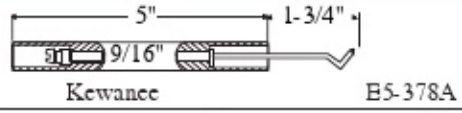
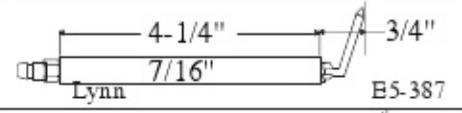
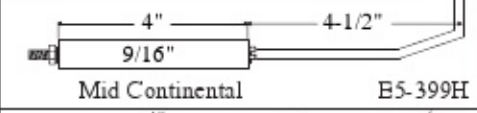
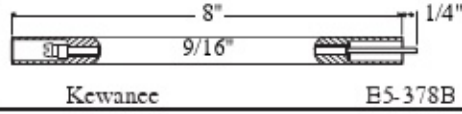
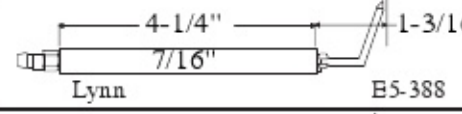
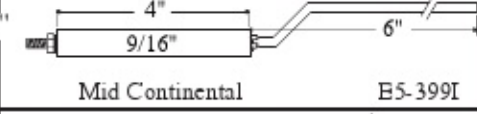
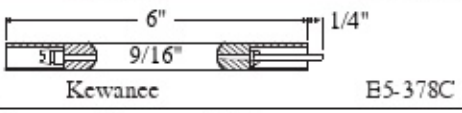
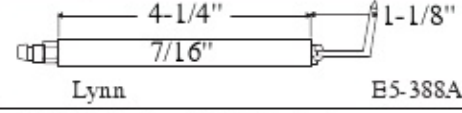
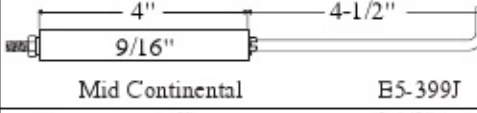
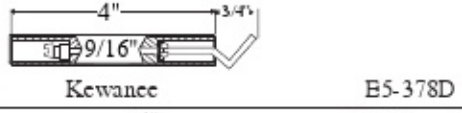
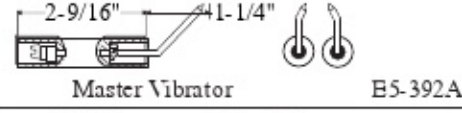
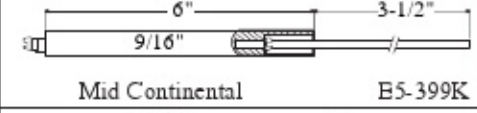
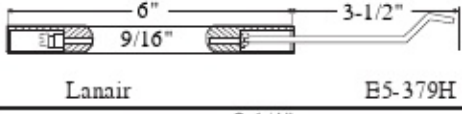
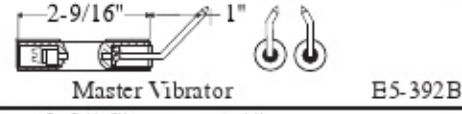
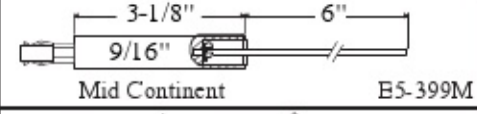
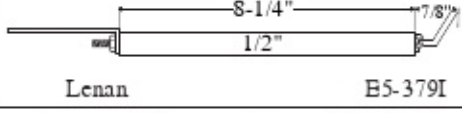
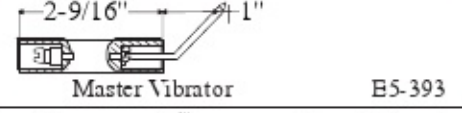
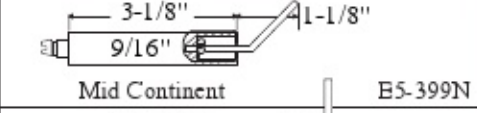
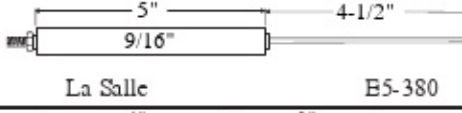
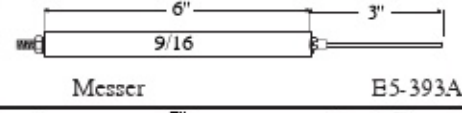
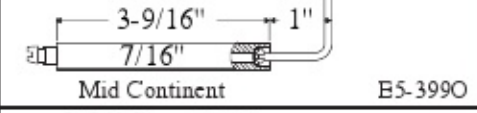
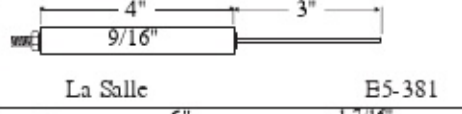
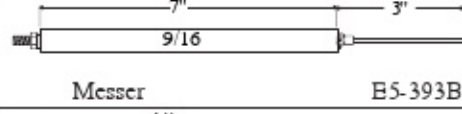
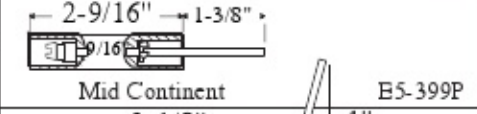
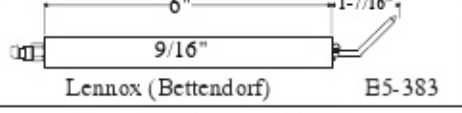
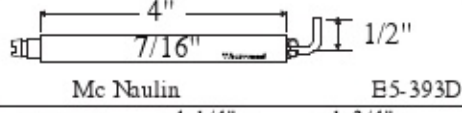
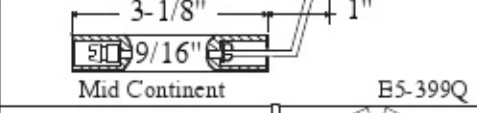
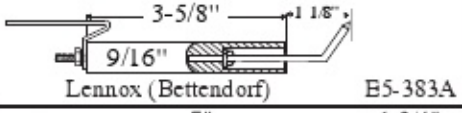
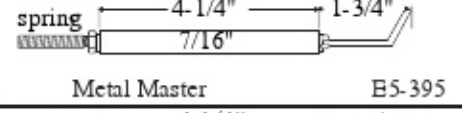
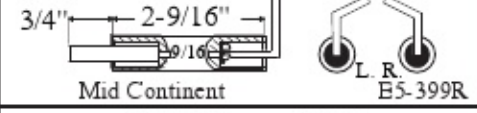
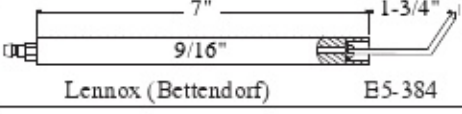
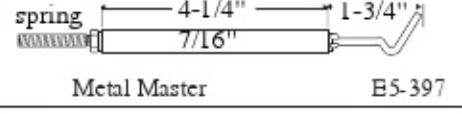
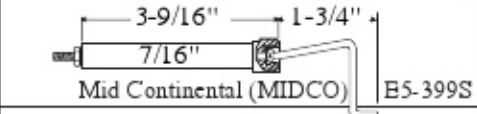
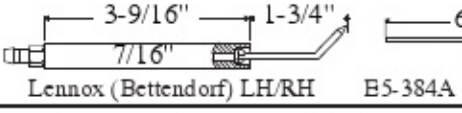
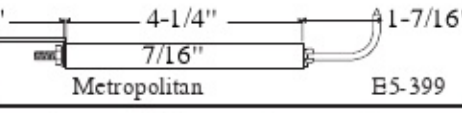
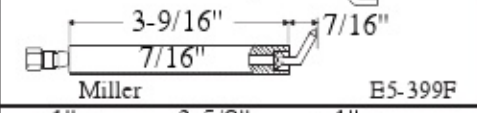
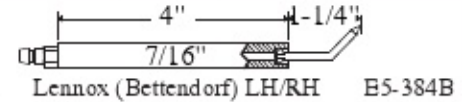

Westwood electrodes & insulators

HIGH DIELECTRIC STRENGTH • PRECISION DIMENSIONS

 <p>Johnson E5-377</p>	 <p>Lennox Lennox Lennox</p> <p>"A" 2" 4" 6"</p> <p>E5-384C E5-384D E5-384E</p>	 <p>Mettler E5-399B</p>
 <p>Johnson Gas E5-377A</p>	 <p>Lisk Savory E5-384F</p>	 <p>Mettler E5-399C</p>
 <p>Kewance E5-378</p>	 <p>Lynn E5-387</p>	 <p>Mid Continental E5-399G</p>
 <p>Kewance E5-378A</p>	 <p>Lynn E5-388</p>	 <p>Mid Continental E5-399H</p>
 <p>Kewance E5-378B</p>	 <p>Lynn E5-388A</p>	 <p>Mid Continental E5-399I</p>
 <p>Kewance E5-378C</p>	 <p>Master Vibrator E5-392A</p>	 <p>Mid Continental E5-399J</p>
 <p>Kewance E5-378D</p>	 <p>Master Vibrator E5-392B</p>	 <p>Mid Continental E5-399K</p>
 <p>Lanair E5-379H</p>	 <p>Master Vibrator E5-393</p>	 <p>Mid Continent E5-399M</p>
 <p>Lenan E5-379I</p>	 <p>Messer E5-393A</p>	 <p>Mid Continent E5-399N</p>
 <p>La Salle E5-380</p>	 <p>Messer E5-393B</p>	 <p>Mid Continent E5-399O</p>
 <p>La Salle E5-381</p>	 <p>Mc Naulin E5-393D</p>	 <p>Mid Continent E5-399P</p>
 <p>Lennox (Bettendorf) E5-383</p>	 <p>spring Metal Master E5-395</p>	 <p>Mid Continent E5-399Q</p>
 <p>Lennox (Bettendorf) E5-383A</p>	 <p>spring Metal Master E5-397</p>	 <p>Mid Continent (MIDCO) E5-399S</p>
 <p>Lennox (Bettendorf) E5-384</p>	 <p>Metropolitan E5-399</p>	 <p>Miller E5-399F</p>
 <p>Lennox (Bettendorf) LH/RH E5-384A</p>	 <p>Mettler E5-399A</p>	 <p>Miller E5-399F1</p>
 <p>Lennox (Bettendorf) LH/RH E5-384B</p>		

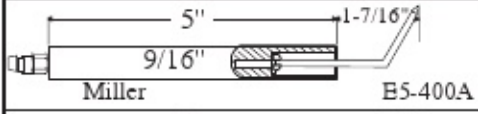
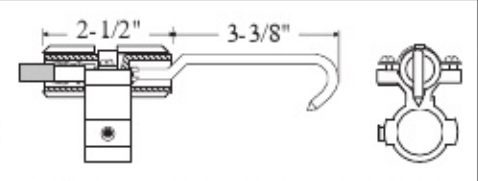
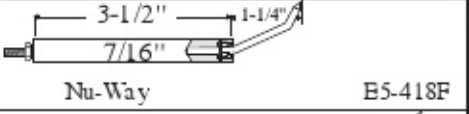
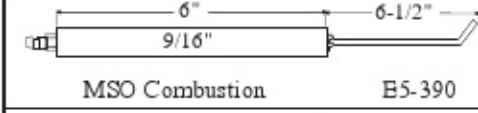
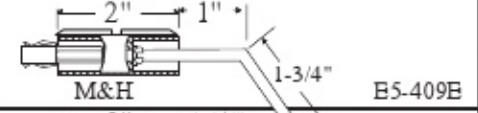
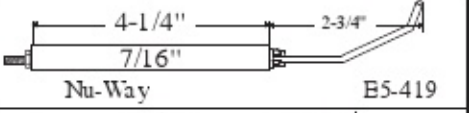
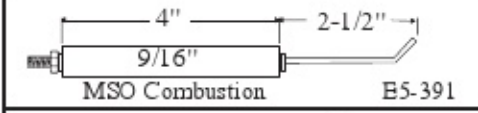
Westwood electrodes & insulators

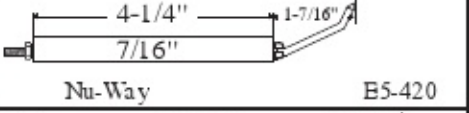
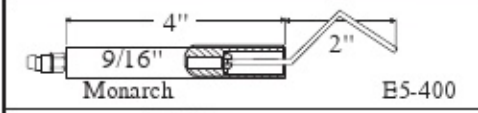
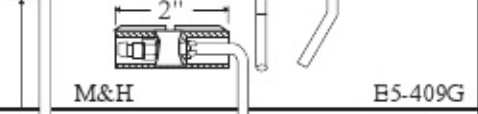
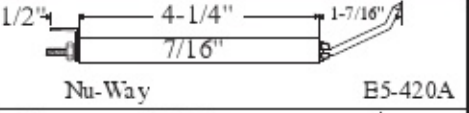
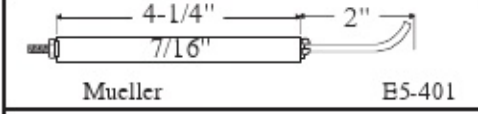
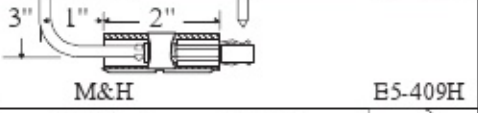
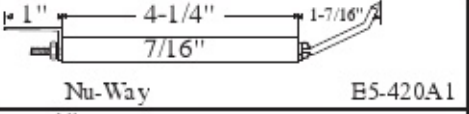
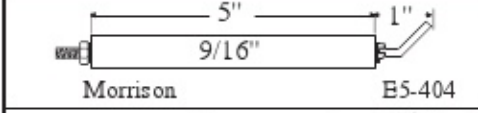
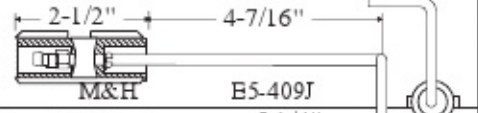
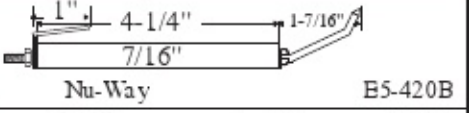
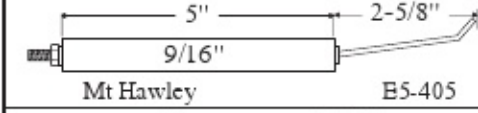
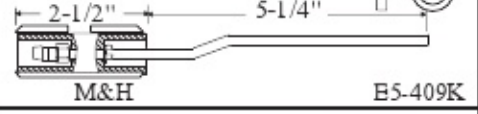
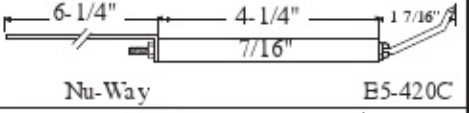
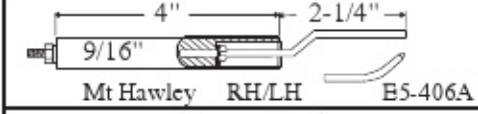
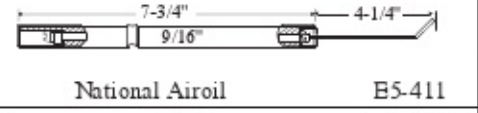
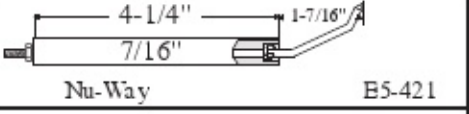
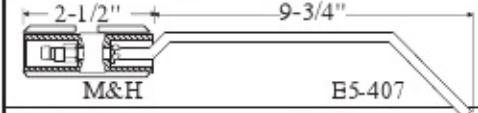
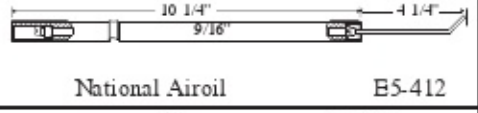
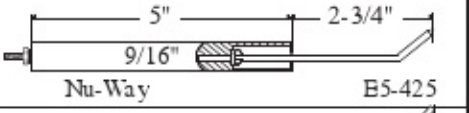
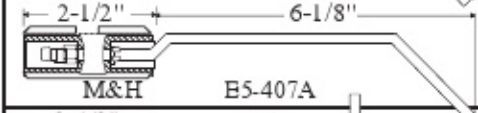
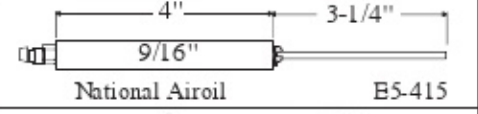
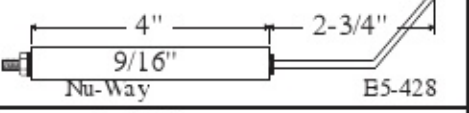
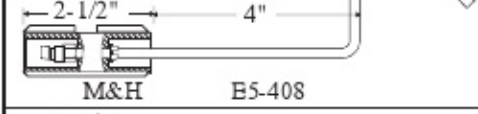
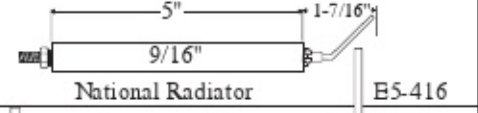
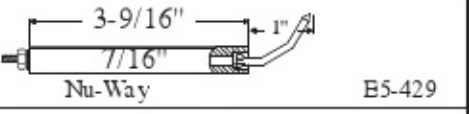
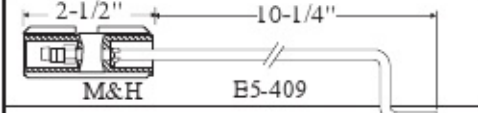
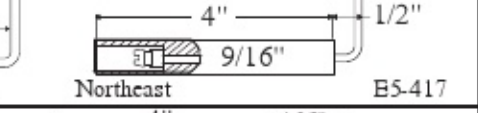
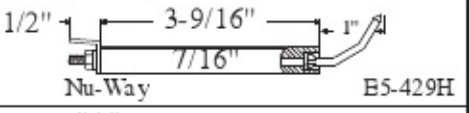
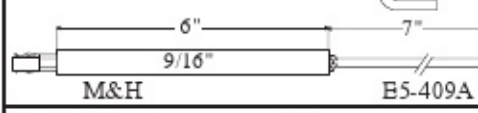
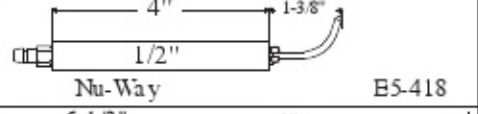
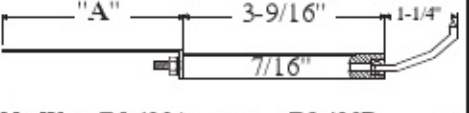
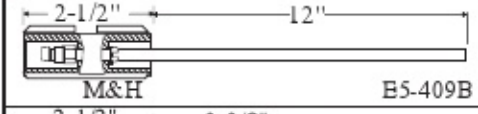
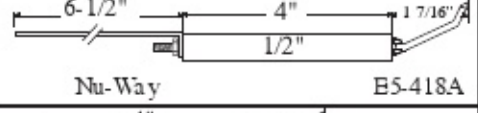
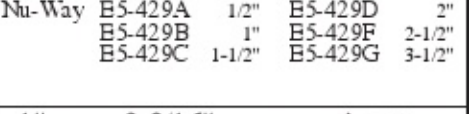
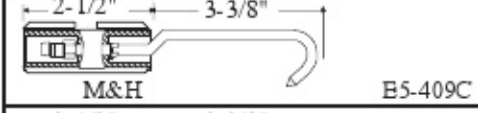
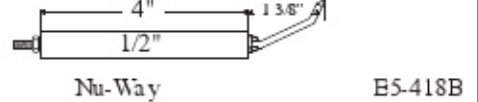
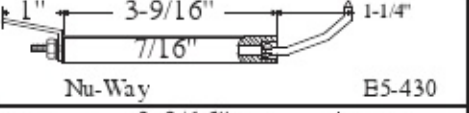
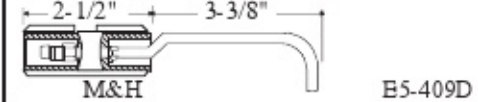
HIGH DIELECTRIC STRENGTH • PRECISION DIMENSIONS

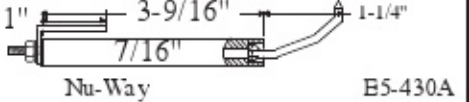
 <p>Miller 9/16" 5" 1-7/16" E5-400A</p>	 <p>M&H (with Bracket) 2-1/2" 3-3/8" E5-409C-2</p>	 <p>Nu-Way 3-1/2" 1-1/4" E5-418F</p>
 <p>MSO Combustion 9/16" 6" 6-1/2" E5-390</p>	 <p>M&H 2" 1" 1-3/4" E5-409E</p>	 <p>Nu-Way 4-1/4" 2-3/4" E5-419</p>
 <p>MSO Combustion 9/16" 4" 2-1/2" E5-391</p>	 <p>M&H 2" 1-1/4" 1-3/4" E5-409F</p>	 <p>Nu-Way 4-1/4" 1-7/16" E5-420</p>
 <p>Monarch 9/16" 4" 2" E5-400</p>	 <p>M&H 2" 1-1/4" E5-409G</p>	 <p>Nu-Way 1/2" 4-1/4" 1-7/16" E5-420A</p>
 <p>Mueller 7/16" 4-1/4" 2" E5-401</p>	 <p>M&H 2" 1" 2" E5-409H</p>	 <p>Nu-Way 1" 4-1/4" 1-7/16" E5-420A1</p>
 <p>Morrisson 9/16" 5" 1" E5-404</p>	 <p>M&H 2-1/2" 4-7/16" E5-409J</p>	 <p>Nu-Way 1" 4-1/4" 1-7/16" E5-420B</p>
 <p>Mt Hawley 9/16" 5" 2-5/8" E5-405</p>	 <p>M&H 2-1/2" 5-1/4" E5-409K</p>	 <p>Nu-Way 6-1/4" 4-1/4" 1-7/16" E5-420C</p>
 <p>Mt Hawley RH/LH 9/16" 4" 2-1/4" E5-406A</p>	 <p>M&H 2-1/2" 9-3/4" E5-407</p>	 <p>Nu-Way 4-1/4" 1-7/16" E5-421</p>
 <p>M&H 2-1/2" 6-1/8" E5-407A</p>	 <p>National Airol 7-3/4" 9/16" 4-1/4" E5-411</p>	 <p>Nu-Way 5" 2-3/4" E5-425</p>
 <p>M&H 2-1/2" 4" E5-408</p>	 <p>National Airol 10 1/4" 9/16" 4-1/4" E5-412</p>	 <p>Nu-Way 4" 2-3/4" E5-428</p>
 <p>M&H 2-1/2" 10-1/4" E5-409</p>	 <p>National Airol 4" 3-1/4" E5-415</p>	 <p>Nu-Way 3-9/16" 1" E5-429</p>
 <p>M&H 2-1/2" 6" 7" E5-409A</p>	 <p>National Radiator 5" 9/16" 1-7/16" E5-416</p>	 <p>Nu-Way 1/2" 3-9/16" 1" E5-429H</p>
 <p>M&H 9/16" 12" E5-409B</p>	 <p>Northeast 4" 9/16" 1/2" E5-417</p>	 <p>Nu-Way "A" 3-9/16" 1-1/4" E5-429A 1/2" E5-429D 2" E5-429B 1" E5-429F 2-1/2" E5-429C 1-1/2" E5-429G 3-1/2"</p>
 <p>M&H 2-1/2" 12" E5-409B</p>	 <p>Nu-Way 4" 1-3/8" E5-418</p>	 <p>Nu-Way 6-1/2" 4" 1-7/16" E5-418A</p>
 <p>M&H 2-1/2" 3-3/8" E5-409C</p>	 <p>Nu-Way 4" 1-3/8" E5-418B</p>	 <p>Nu-Way 1" 3-9/16" 1-1/4" E5-430</p>
 <p>M&H 2-1/2" 3-3/8" E5-409D</p>	 <p>Nu-Way 1" 3-9/16" 1-1/4" E5-430A</p>	 <p>Nu-Way 1" 3-9/16" 1-1/4" E5-430A</p>

Please order by  No.











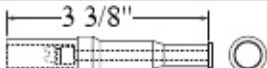
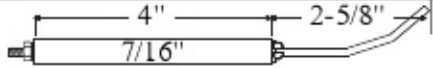
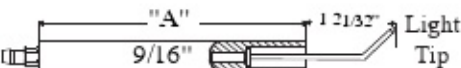
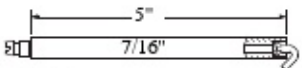

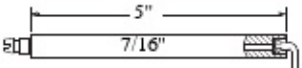
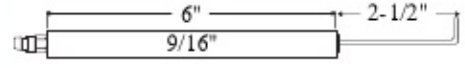

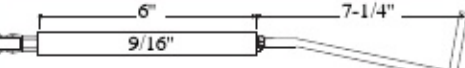
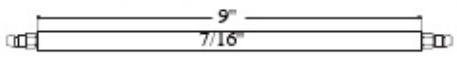
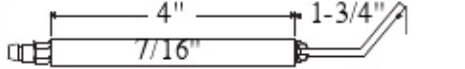
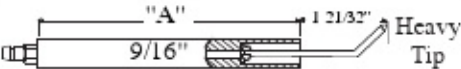
Westwood electrodes & insulators

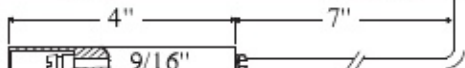
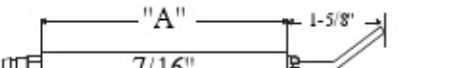
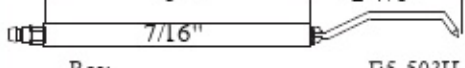
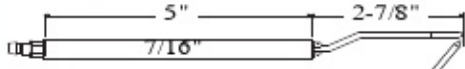
HIGH DIELECTRIC STRENGTH • PRECISION DIMENSIONS

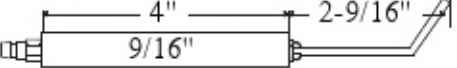
<p>Oil Equipment B5-432</p>	<p>Petro Petro Petro</p> <p>"A" 1-1/2" 2" 18"</p> <p>B5-468B B5-468C B5-468D</p>	<p>Power Flame B5-477I</p> <p>Power Flame B5-477J</p>
<p>Orr & Sembower B5-443</p>	<p>Power Flame B5-475-1</p>	<p>Power Flame B5-477K</p>
<p>Orr & Sembower B5-448</p>	<p>Power Flame B5-475</p>	<p>Power Flame B5-478</p>
<p>Orr & Sembower B5-449</p>	<p>Power Flame B5-475A</p>	<p>Power Flame B5-478A</p>
<p>Orr & Sembower B5-451</p>	<p>Power Flame (Kanthal tip) B5-475B</p>	<p>Power Flame B5-478B</p>
<p>Orr & Sembower B5-452</p>	<p>Power Flame B5-477</p>	<p>Power Flame B5-478C</p>
<p>Orr & Sembower B5-453</p>	<p>"A" "B"</p> <p>Power Flame 5.81" .50" B5-477A Power Flame 6.44" .38" B5-477B Power Flame 6.88" .47" B5-477C</p>	<p>Power Flame B5-478D</p>
<p>Peabody B5-457</p>	<p>"A" "B"</p> <p>Power Flame 5.81" 6.30" B5-477A-1 Power Flame 6.44" 6.69" B5-477B-1 Power Flame 6.88" 8.66" B5-477C-1</p>	<p>Power Flame B5-478E</p>
<p>Peabody B5-458</p>	<p>Power Flame B5-479</p>	<p>Power Flame B5-479A</p>
<p>Penn Boiler B5-461</p>	<p>Power Flame B5-477D</p>	<p>Power Flame B5-479B</p>
<p>Petro B5-465</p>	<p>Power Flame B5-477E</p>	<p>Power Flame B5-479C</p>
<p>Petro B5-465B</p>	<p>Power Flame B5-477F</p>	<p>Power Flame B5-479D</p>
<p>Petro B5-466</p>	<p>Power Flame (Stainless tip) B5-477G</p>	<p>Power Flame B5-479E</p>
<p>Petro Petro Petro Petro</p> <p>1-1/2" 2" 18" 6"</p> <p>B5-467 B5-467A B5-467B B5-467G</p>	<p>Power Flame B5-477H</p>	<p>Power Flame B5-479B1</p>
<p>Petro B5-468A</p>		

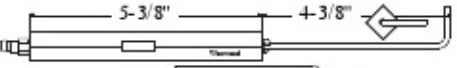
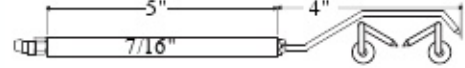

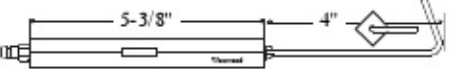
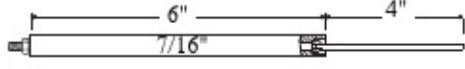
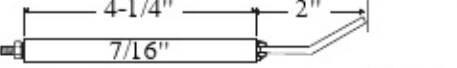
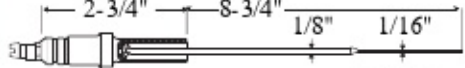
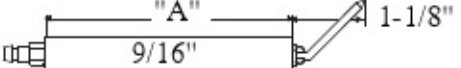
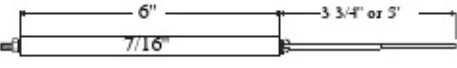
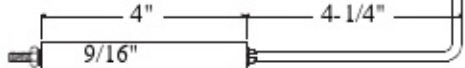
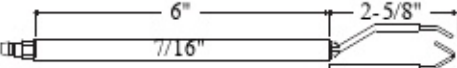

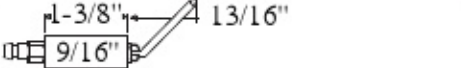
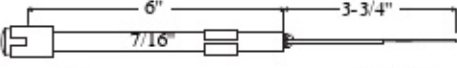
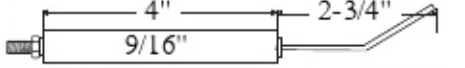
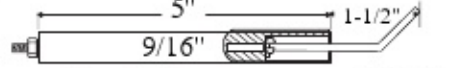
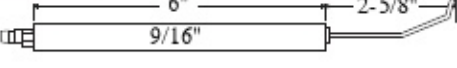
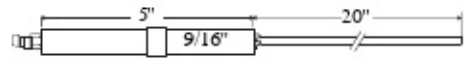
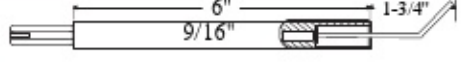



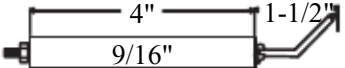
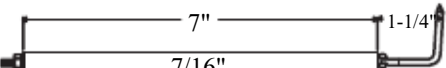
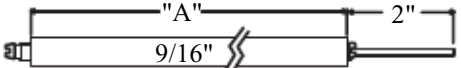
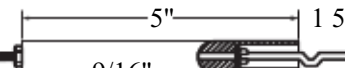
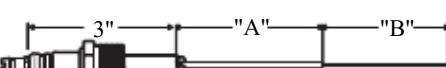
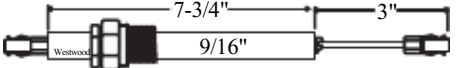
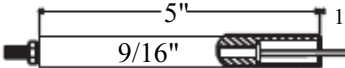
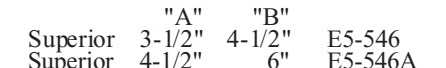
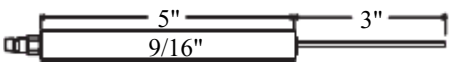
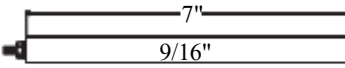
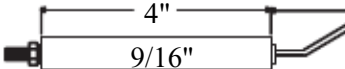
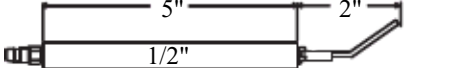
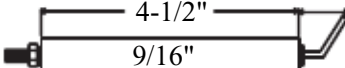
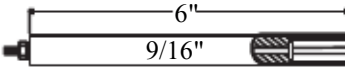
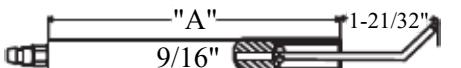
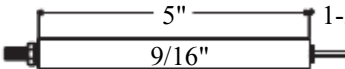
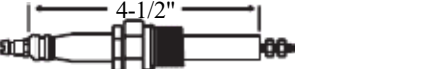
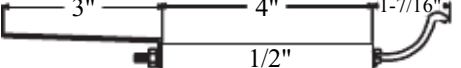
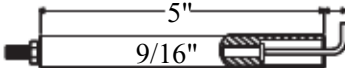

Westwood electrodes & insulators

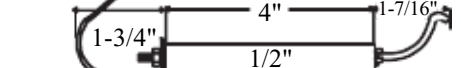
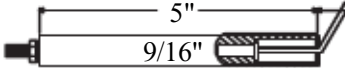
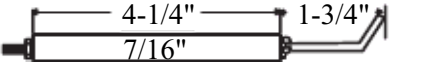
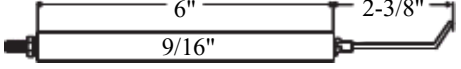
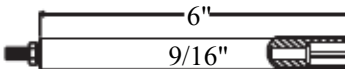
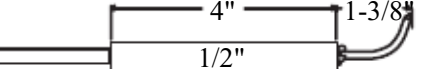
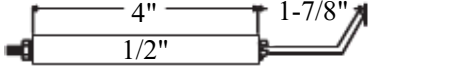
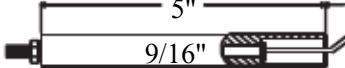
HIGH DIELECTRIC STRENGTH • PRECISION DIMENSIONS

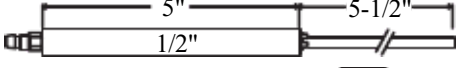
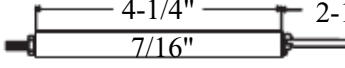
 <p>Preferred Utilities E5-471A</p>	 <p>Ray E5-502</p>	 <p>Light Tip</p>
 <p>PVI E5-473F</p>	 <p>Ray E5-503A</p>	<p>Shellhead 4" E5-513-4 Shellhead 5" E5-513-5 Shellhead 6" E5-513-6 Shellhead 7" E5-513-7 Shellhead 8" E5-513-8 Shellhead 9" E5-513-9 Shellhead 10" E5-513-10 Shellhead 11" E5-513-11 Shellhead 12" E5-513-12 Shellhead 13" E5-513-13 Shellhead 14" E5-513-14</p>
 <p>PVI E5-473G</p>	 <p>Ray E5-503D</p>	
 <p>Pyronics E5-474C-1 6" E5-474C-2 12"</p>	 <p>Ray E5-503E</p>	
 <p>Pyronics E5-474E</p>	 <p>Ray E5-503F</p>	 <p>Heavy Tip</p>
 <p>Quiet Automatic E5-480</p>	 <p>Ray E5-503G</p>	<p>Shellhead 4" E5-514-4 Shellhead 5" E5-514-5 Shellhead 6" E5-514-6 Shellhead 7" E5-514-7 Shellhead 8" E5-514-8 Shellhead 9" E5-514-9 Shellhead 10" E5-514-10 Shellhead 11" E5-514-11 Shellhead 12" E5-514-12 Shellhead 13" E5-514-13 Shellhead 14" E5-514-14</p>
 <p>Quiet Heet 4-1/4" E5-483 Quiet Heet 5" E5-483-5 Quiet Heet 6" E5-483-6</p>	 <p>Ray E5-503H</p>	
	 <p>Ray E5-503I</p>	 <p>Light Tip</p>
 <p>Radiant E5-490</p>	 <p>Ray E5-503J</p>	<p>Shellhead 5" E5-515-5 Shellhead 6" E5-515-6 Shellhead 7" E5-515-7 Shellhead 8" E5-515-8</p>
 <p>Rails E5-489B</p>	 <p>Ray E5-503M</p>	 <p>Heavy Tip</p>
 <p>Rails E5-489C</p>	 <p>Ray E5-503P</p>	<p>Shellhead 5" E5-516-5 Shellhead 6" E5-516-6</p>
 <p>Rasol E5-494</p>	 <p>Ray E5-503Q</p>	 <p>Light Tip</p>
 <p>Ray E5-499 3-3/4" E5-499C 5"</p>	 <p>Robert Gordon E5-506B</p>	<p>Silent Glow 3" E5-523 Silent Glow 4" E5-524 Silent Glow 5" E5-525 Silent Glow 6" E5-526 Silent Glow 11-3/4" E5-527</p>
 <p>Ray E5-499D</p>	 <p>Robert Gordon E5-506C</p>	 <p>Silent Glow E5-523A</p>
 <p>Ray E5-500</p>	 <p>Sandberg E5-510</p>	 <p>Stewart Warner E5-545</p>
 <p>Ray E5-501</p>	 <p>Scully Fastlite E5-512A</p>	 <p>Stewart Warner E5-545A</p>

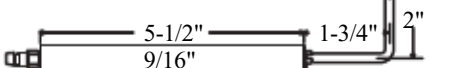
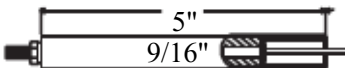

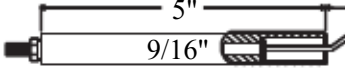
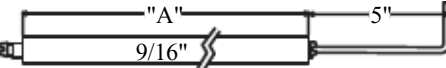

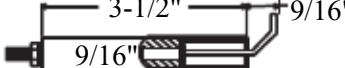





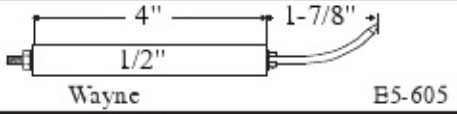
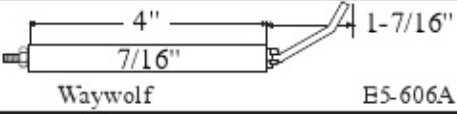
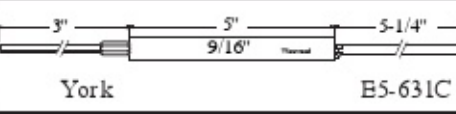
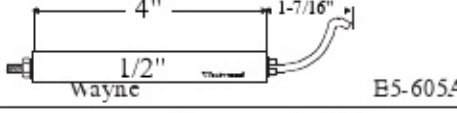
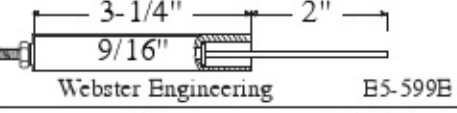
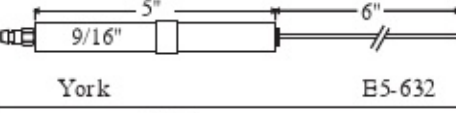
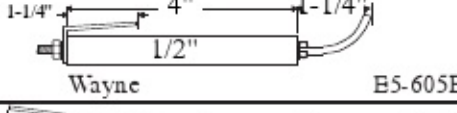
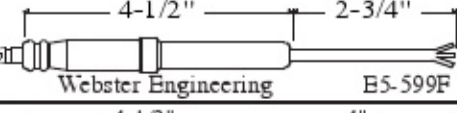
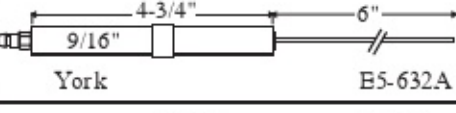
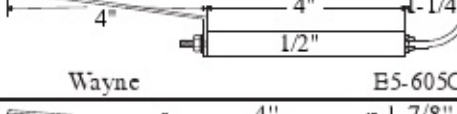
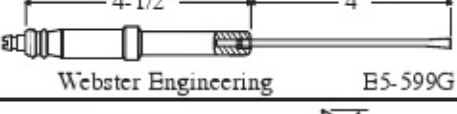
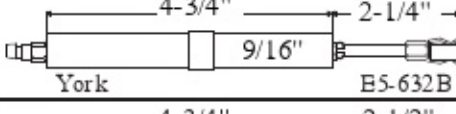
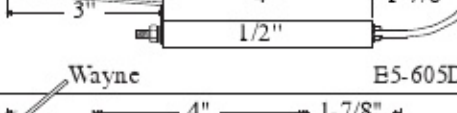
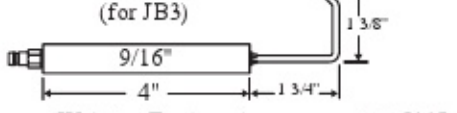
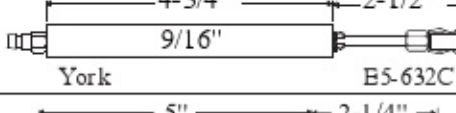
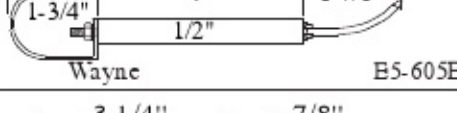
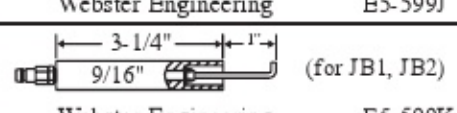
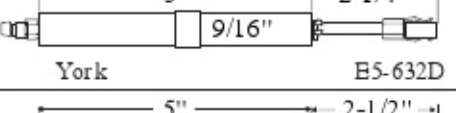

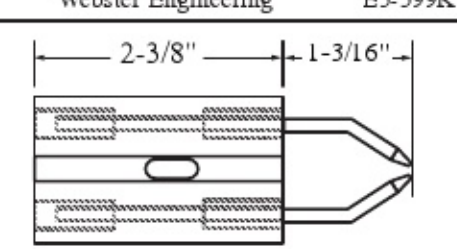
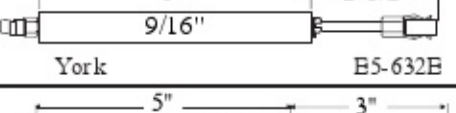
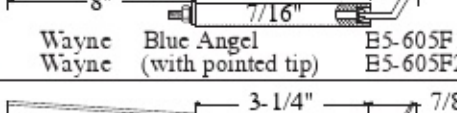
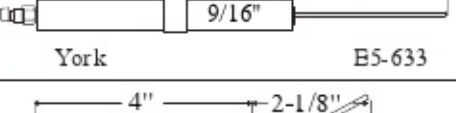
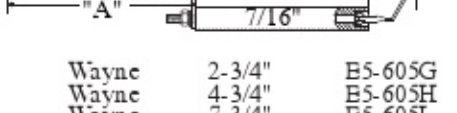

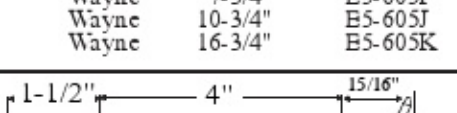
Westwood electrodes & insulators

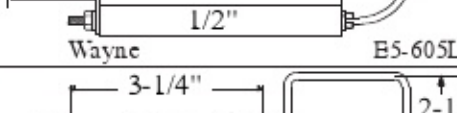
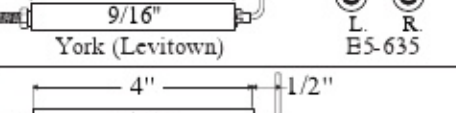
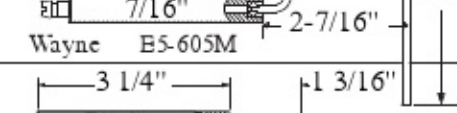
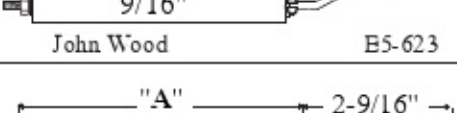
HIGH DIELECTRIC STRENGTH • PRECISION DIMENSIONS

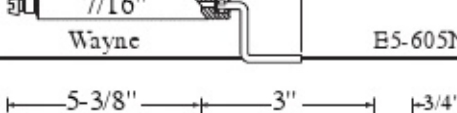
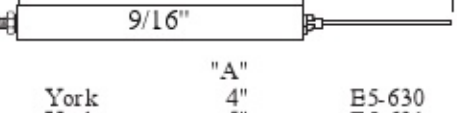
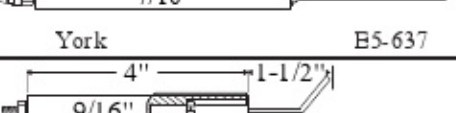
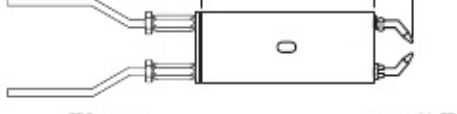
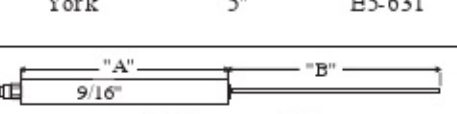
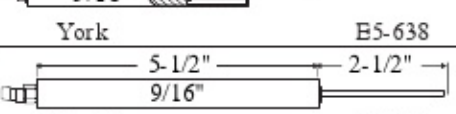
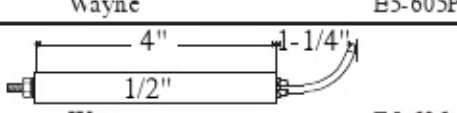
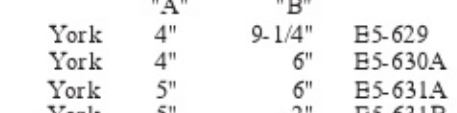
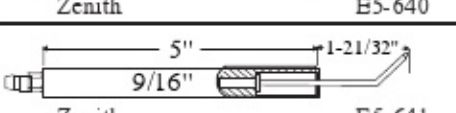
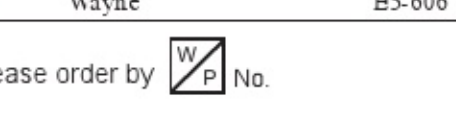
 Sun Ray E5-550	 Sun Ray E5-559N	 Todd "A" 8-3/4" E5-578 Todd 10-1/4" E5-578A Todd 12" E5-579 Todd 14" E5-580 Todd 17" E5-581 Todd 19" E5-582 Todd 21" E5-582A Todd 23" E5-582B Todd 24" E5-582C
 Sun Ray E5-553	 Superior "A" "B" E5-546 Superior 3-1/2" 4-1/2" E5-546A Superior 4-1/2" 6" E5-546B Superior 10-1/4" 5" E5-546C Superior 3" 3" E5-546D Superior 3" 2-1/4" E5-546E Superior 8-1/2" 3" E5-546F Superior 3-1/2" 8" E5-546G Superior 12-1/2" 4" E5-546H	 Tomado Todd E5-588B
 Sun Ray E5-556	 Superior E5-547	 Torrid Heat E5-584
 Sun Ray E5-557	 Sun Ray E5-558	 Volcano E5-590
 Sun Ray E5-559	 Sun Ray E5-559B	 Waltham 3-1/2" E5-600-3 Waltham 4" E5-600-4 Waltham 5" E5-600-5 Waltham 6" E5-600-6
 Sun Ray E5-559C	 Superior Bulkhead E5-547D	 Wayne E5-601A
 Sun Ray E5-559D	 Superior E5-547F	 Wayne E5-601B
 Sun Ray E5-559E	 Terry Burner E5-562	 Wayne E5-603
 Sun Ray E5-559F	 Thatcher E5-560	 Wayne E5-604
 Sun Ray E5-559H	 Timken "F" Adjustable E5-566	 Wayne E5-604A
 Sun Ray E5-559J	 Timken "C" Adjustable E5-567	 Wayne E5-604B
 Sun Ray E5-559K	 Todd E5-577A	 Wayne E5-604C
 Sun Ray E5-559L	 Todd "A" 5" E5-579A Todd 13" E5-579B Todd 16" E5-579C Todd 19" E5-579D Todd 21" E5-579E Todd 22" E5-579F	 Wayne E5-604D
 Sun Ray E5-559M		

Westwood electrodes & insulators

HIGH DIELECTRIC STRENGTH • PRECISION DIMENSIONS

 Wayne B5-605	 Waywolf B5-606A	 York B5-631C
 Wayne B5-605A	 Webster Engineering B5-599E	 York B5-632
 Wayne B5-605B	 Webster Engineering B5-599F	 York B5-632A
 Wayne B5-605C	 Webster Engineering B5-599G	 York B5-632B
 Wayne B5-605D	 (for JB3) Webster Engineering B5-599J	 York B5-632C
 Wayne B5-605E	 Webster Engineering B5-599K	 York B5-632D
 Wayne Blue Angel B5-605F	 Weil-McLain, electrode only B5-598 Weil-McLain electrode w/leads B5-598A Leads only (former WMK-150) B5-598B	 York B5-632E
 Wayne Blue Angel B5-605F1		 York B5-633
 Wayne Blue Angel (with pointed tip) B5-605F2		 York B5-634
 Wayne "A" B5-605G		 York B5-634A
 Wayne B5-605H		 York (Levittown) B5-635
 Wayne B5-605I	 Williams B5-624	 York B5-636
 Wayne B5-605J	 John Wood B5-623	 York B5-637
 Wayne B5-605K	 York "A" B5-630	 York B5-638
 Wayne B5-605L	 York B5-631	 York B5-639
 Wayne B5-605M	 York "A" B5-629	 Zenith B5-640
 Wayne B5-605N	 York B5-630A	 Zenith B5-641
 Wayne B5-605P	 York B5-631A	
 Wayne B5-606	 York B5-631B	

Please order by  No.

Westwood

ELECTRODE KITS

FOR THE SERVICE PROFESSIONAL

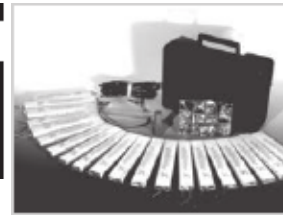
**ELECTRODE & INSULATOR KITS****Serviceman's Deluxe Kit****OEM Electrodes - 2 ea.**

ABC: E5-146

Beckett: E5-151E, E5-151O

Carlin: E5-188B, E5-188N, E5-188K

Quiet Heet: E5-483

Wayne: E5-604, E5-605, E5-605B,

E5-605F, E5-606

Rajah™ Terminals - 10 ea.

E9-CT, E9-SS, E9-R-2, E9-RAC, E9-SF,

E9-BS 6-32, E9-BS 10-32,

E9-HS 6-32 (5 ea.), E9-HS 10-32 (5 ea.),

6-32 nut, 10-32 nut

Standard Electrodes - 2 ea.

E5-1M4, E5-2M4, E5-2M5, E5-2M6,

E5-4M4, E5-3M4, E5-3M5, E5-3M6

Also includes

5 feet of GTO-15 ignition cable

1 set (2) T100-230 electrode benders

1 - T100-220 electrode gauge

1 set (2) T100-70 jumpers

1 - NAS gauge™ nozzle gauge

1 - Coupler Popper™ tool

1 - Plastic carrying case

 No. E5-2001
Serviceman's Super Kits

Same contents as the E5-2001 Deluxe Kit, less the NAS gauge™ and Coupler Popper™ in a plastic carrying case

 No. E5-1897

Same contents as the E5-2001 Deluxe Kit, less the NAS gauge™ and Coupler Popper™ in a cardboard box

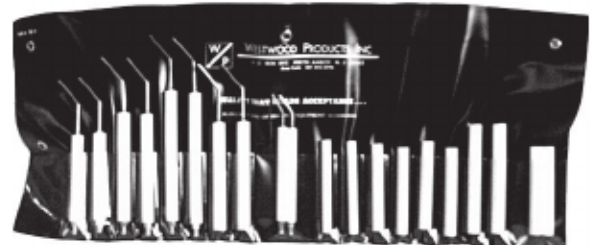
 No. E5-1897-C
ELECTRODE & INSULATOR ROLL-UP KITS**Contains:****Electrodes - 2 ea.**E5-3M4 (9/16"x4"), E5-3M5 (9/16"x5"),
E5-3M6 (9/16"x6"), E5-3F5 (9/16"x5"),
E5-483 (Quiet Heet)**Insulators - 2 ea.**E5-1M4-1/4 (7/16"x4-1/4"), E5-4M4 (1/2"x4"),
E5-2M4 (9/16"x4"), E5-2M5 (9/16"x5"),
E5-3M4 (9/16"x4")
 No. E5-595
Contains:**Electrodes - 2 ea.**E5-188N (Carlin), E5-151E (Beckett),
E5-605 (Wayne), E5-2M4 (9/16"x4"),E5-2M5 (9/16"x5"), E5-2M6 (9/16"x6"),
E5-2F5 (female 5"), E5-2F6 (female 6")**Insulators - 2 ea.**E5-1M4-1/4 (7/16"x4-1/4"), E5-3M4 (9/16"x4"),
E5-2M4 (9/16"x4"), E5-2M5 (9/16"x5"),
E5-2M6 (9/16"x6"), E5-2F5 (female 5"),
E5-2F6 (female 6"), E5-4M4 (1/2"x4")
 No. E5-920

Westwood

ELECTRODE KITS

FOR THE SERVICE PROFESSIONAL

**ELECTRODE & INSULATOR ROLL-UP KITS (Continued)**

For Servicing
Beckett Burners

Contains these electrodes:

4 · E5-151E	2 · E5-151D
2 · E5-151E1	2 · E5-151R
2 · E5-151O	2 · E5-151G
2 · E5-151F	2 · E5-151J
2 · E5-151	

 No. E5-BK-400

For Servicing
Carlin Burners

Contains these electrodes:



4 · E5-188N	2 · E5-188P
4 · E5-188B	2 · E5-188Q
2 · E5-188K	2 · E5-188R3
2 · E5-188R-2	2 · E5-188N4
2 · E5-188H	

 No. E5-CK-300

For Servicing
Wayne Burners

Contains these electrodes:

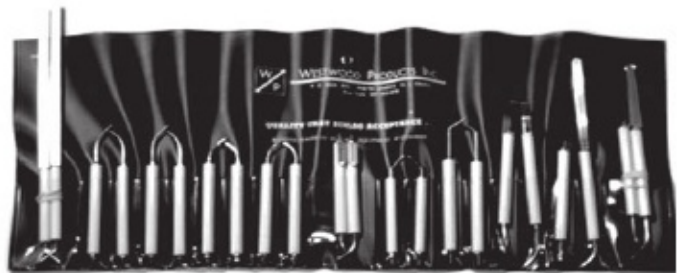
4 · E5-605	2 · E5-605E
4 · E5-606	2 · E5-605C
2 · E5-605B	2 · E5-605D
2 · E5-605F	2 · E5-605F1
2 · E5-604	

 No. E5-WK-500

Take a look ...

PORCELAIN CUTTER No. T100-370 on page T17
&
RAJAH TERMINAL KITS on page E33

Please order by  No.

rev. 5-1-07

E16

Westwood
AUBURN IGNITION PRODUCTS

IGNITORS • FLAME RODS • LIQUID LEVEL ELECTRODES

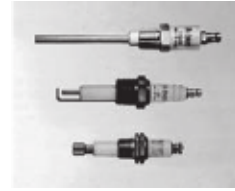

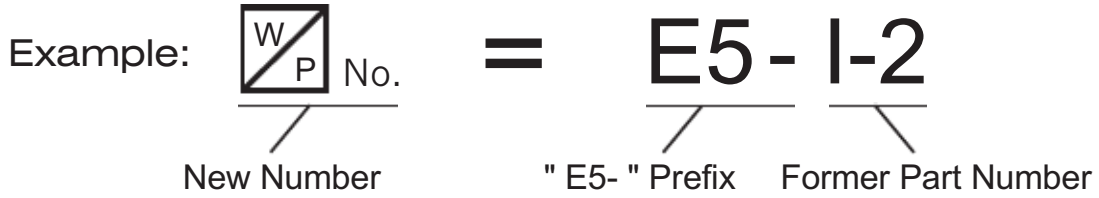

NOTE: Auburn ignition products part numbers are now " E5- " followed by the former number.



 No.	Ref. No.
E5-149T-1-090	149T-1-090

 No.	Ref. No.
E5-I-2-EI-2	I-2-EI-2

 No.	Ref. No.
E5-F-68	F-68

 No.	Ref. No.	"A" DIM.	"B" DIM.
E5-I-2	I-2	8.00	4.50
E5-I-2-1	I-2-1	15.50	12.00
E5-I-2-2	I-2-2	27.50	24.00

 No.	Ref. No.
E5-F-140	F-140

New!

* Dimensions marked with an asterisk are standard lengths - Other lengths available upon request

AUBURN ELECTRODES

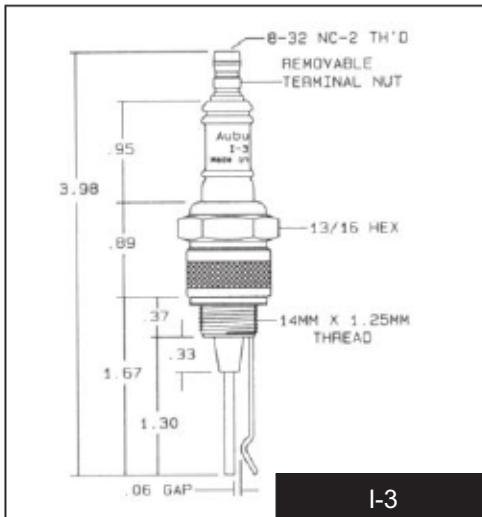

I-3

<input checked="" type="checkbox"/> No.	Ref. No.
E5-I-3	I-3

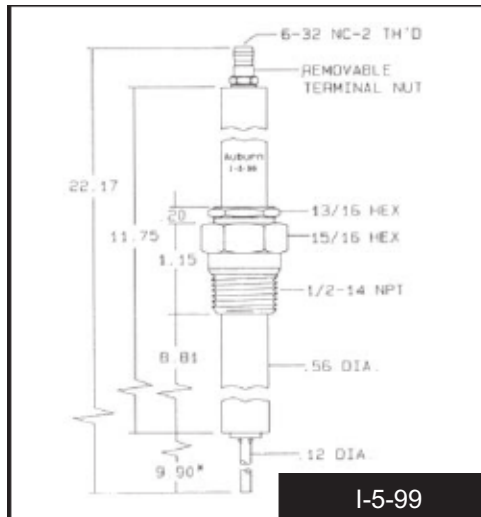

I-5-99

<input checked="" type="checkbox"/> No.	Ref. No.
E5-I-5-99	I-5-99

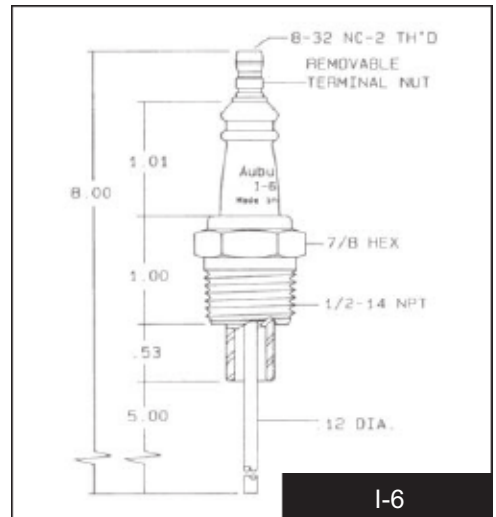

I-6

<input checked="" type="checkbox"/> No.	Ref. No.
E5-I-6	I-6

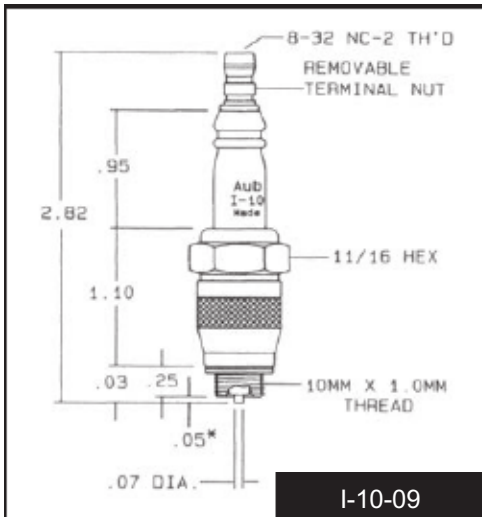

I-10-09

<input checked="" type="checkbox"/> No.	Ref. No.
E5-I-10-09	I-10-09

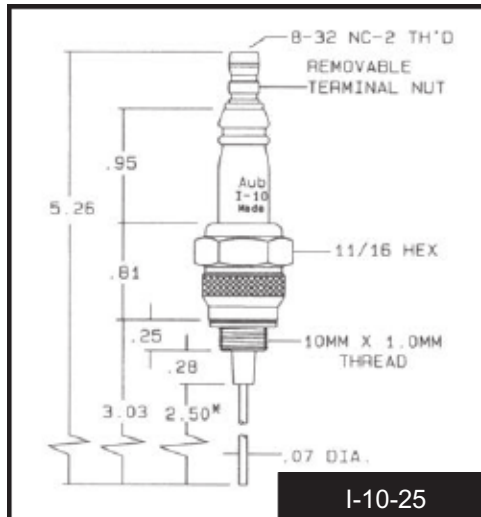

I-10-25

<input checked="" type="checkbox"/> No.	Ref. No.
E5-I-10-25	I-10-25

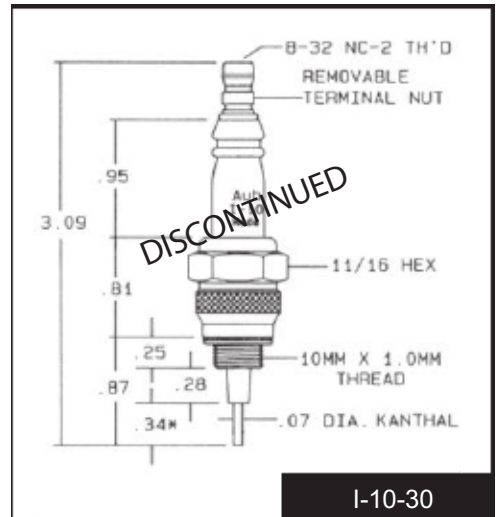

I-10-30

<input checked="" type="checkbox"/> No.	Ref. No.
E5-I-10-30	I-10-30

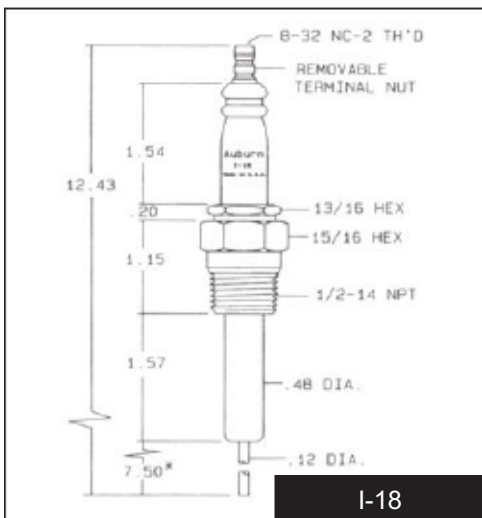

I-18

<input checked="" type="checkbox"/> No.	Ref. No.
E5-I-18	I-18

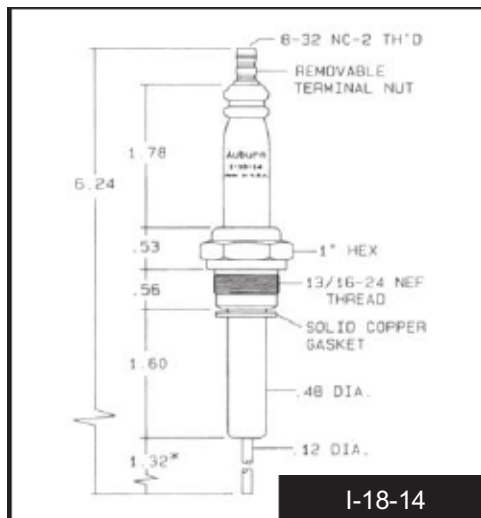

I-18-14

<input checked="" type="checkbox"/> No.	Ref. No.
E5-I-18-14	I-18-14

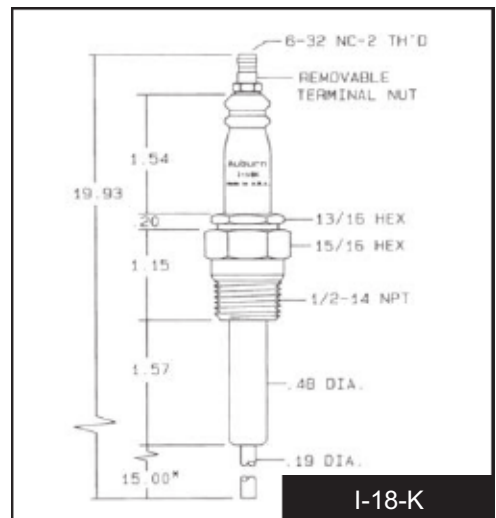

I-18-K

<input checked="" type="checkbox"/> No.	Ref. No.
E5-I-18-K	I-18-K

* Dimensions marked with an asterisk are standard lengths - Other lengths available upon request

Please order by No.

AUBURN ELECTRODES

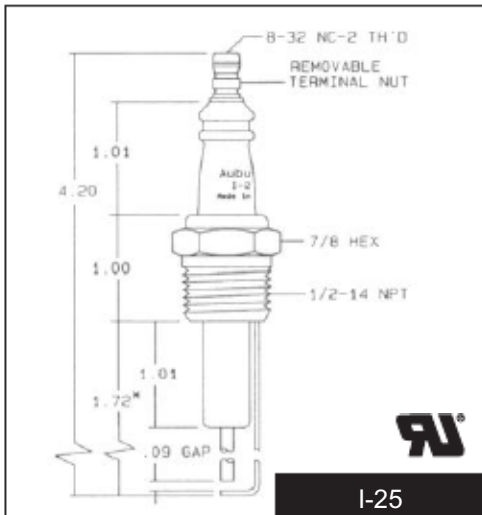

I-25

<input checked="" type="checkbox"/> No.	Ref. No.
E5-I-25	I-25

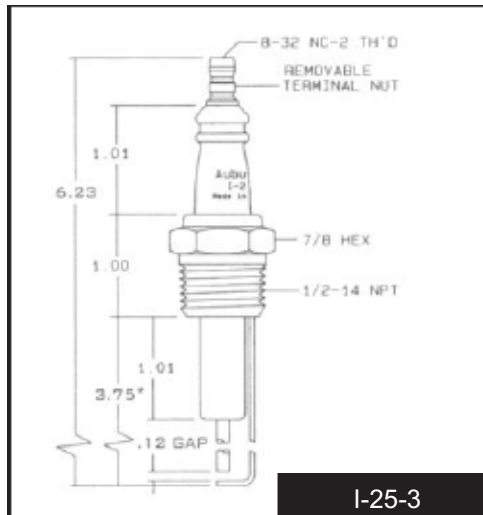

I-25-3

<input checked="" type="checkbox"/> No.	Ref. No.
E5-I-25-3	I-25-3

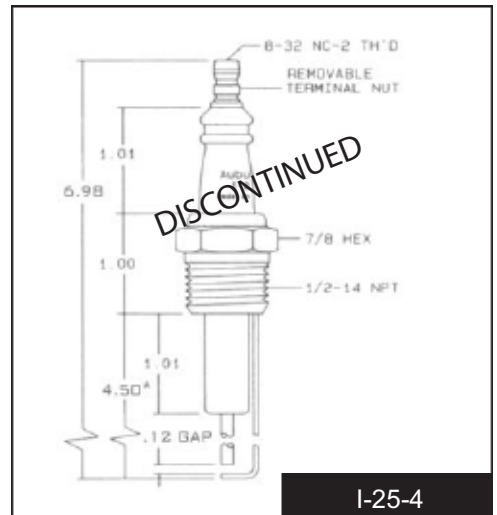

I-25-4

<input checked="" type="checkbox"/> No.	Ref. No.
E5-I-25-4	I-25-4

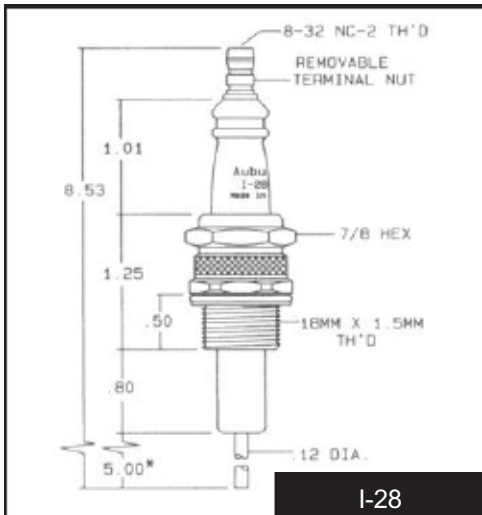

I-28

<input checked="" type="checkbox"/> No.	Ref. No.
E5-I-28	I-28

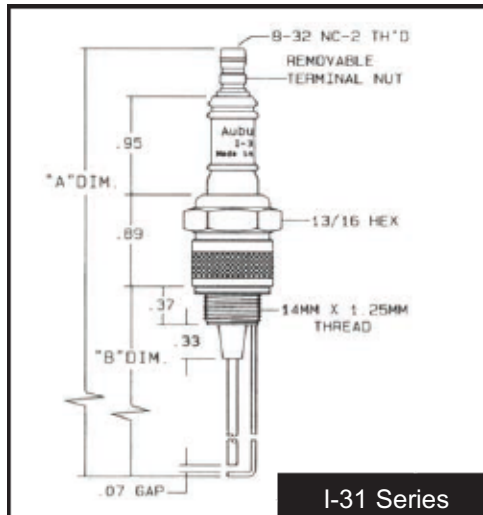

I-31 Series

<input checked="" type="checkbox"/> No.	Ref. No.	"A"	"B"	ELEC. MAT.
E5-I-31	I-31	3.68	1.37	NICKEL
E5-I-31-1	I-31-1	4.17	1.87	NICKEL
E5-I-31-2	I-31-2	4.81	2.50	NICKEL
E5-I-31-3	I-31-3	4.17	1.87	INCONEL
E5-I-31-5	I-31-5	6.43	4.12	NICKEL
E5-I-31-6	I-31-6	3.31	1.06	NICKEL

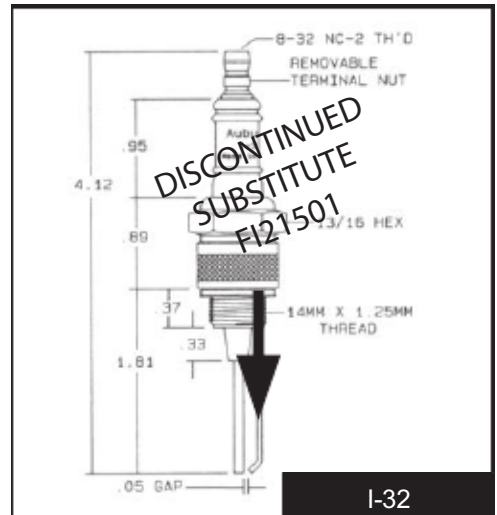

I-32

<input checked="" type="checkbox"/> No.	Ref. No.
E5-I-32	I-32

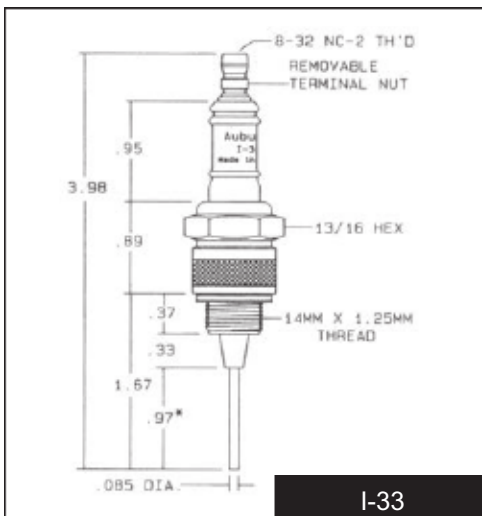

I-33

<input checked="" type="checkbox"/> No.	Ref. No.
E5-I-33	I-33

As a major distributor of Auburn Ignition Products, Westwood can special order any Auburn item not shown in this catalog and get it to you fast!

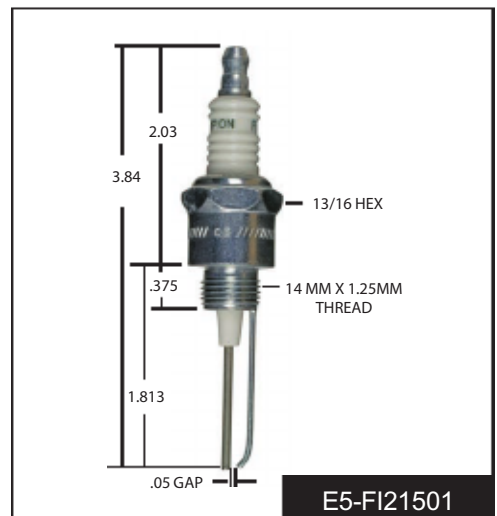

E5-FI21501

<input checked="" type="checkbox"/> No.	Ref. No.
E5-FI21501	FI21501

* Dimensions marked with an asterisk are standard lengths - Other lengths available upon request

AUBURN ELECTRODES

I-63

<input checked="" type="checkbox"/> No.	Ref. No.
E5-I-63	I-63

I-64 Series

I-75-5

<input checked="" type="checkbox"/> No.	Ref. No.
E5-I-75-5	I-75-5

I-75-6

<input checked="" type="checkbox"/> No.	Ref. No.
E5-I-75-6	I-75-6

<input checked="" type="checkbox"/> No.	Ref. No.	"A"	"B"	GAP	ELEC. MAT.
E5-I-64-1	I-64-1	4.20	1.72	.090	NI
E5-I-64-3	I-64-3	6.24	3.75	.090	NI
E5-I-64-4 ¹	I-64-4	3.60	1.12	.100	NI
E5-I-64-7	I-64-7	4.70	2.21	.100	NI

¹UL Recognized Component

I-78

<input checked="" type="checkbox"/> No.	Ref. No.
E5-I-78	I-78

I-82

<input checked="" type="checkbox"/> No.	Ref. No.
E5-I-82	I-82

As a major distributor of Auburn Ignition Products, Westwood can special order any Auburn item not shown in this catalog and get it to you fast!

* Dimensions marked with an asterisk are standard lengths - Other lengths available upon request

Please order by No.

AUBURN ELECTRODES

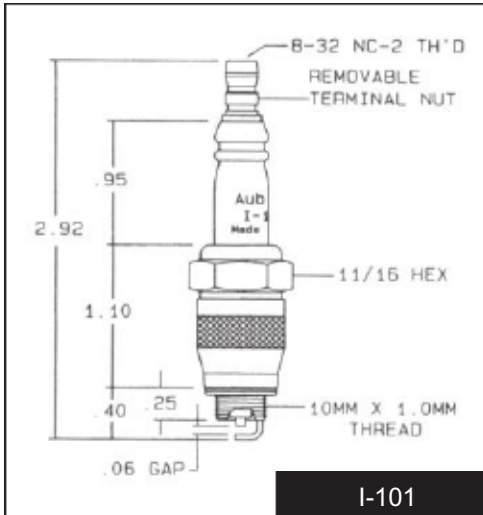

I-101

<input checked="" type="checkbox"/> No.	Ref. No.
E5-I-101	I-101

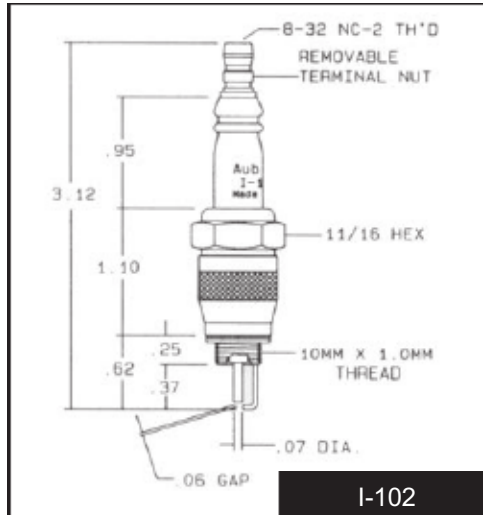

I-102

<input checked="" type="checkbox"/> No.	Ref. No.
E5-I-102	I-102

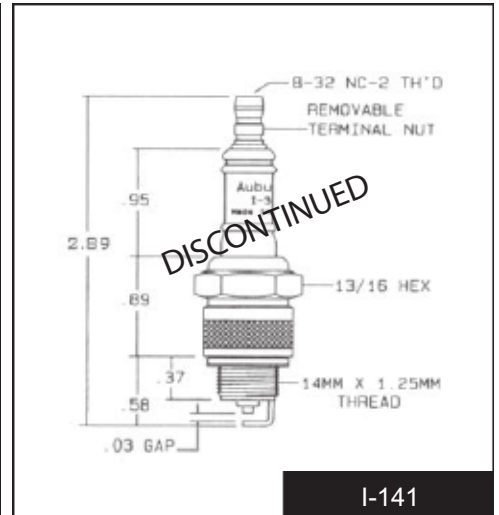

I-141

<input checked="" type="checkbox"/> No.	Ref. No.
E5-I-141	I-141

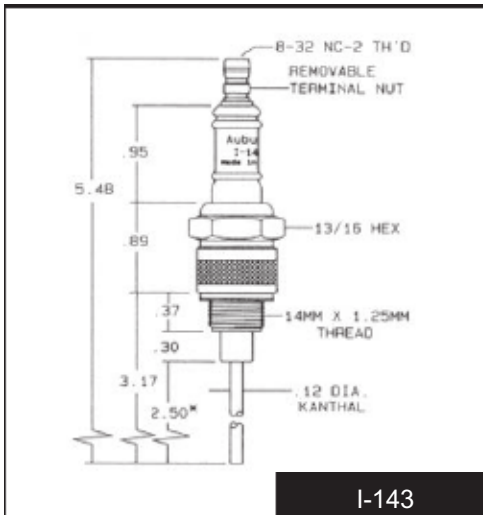

I-143

<input checked="" type="checkbox"/> No.	Ref. No.
E5-I-143	I-143

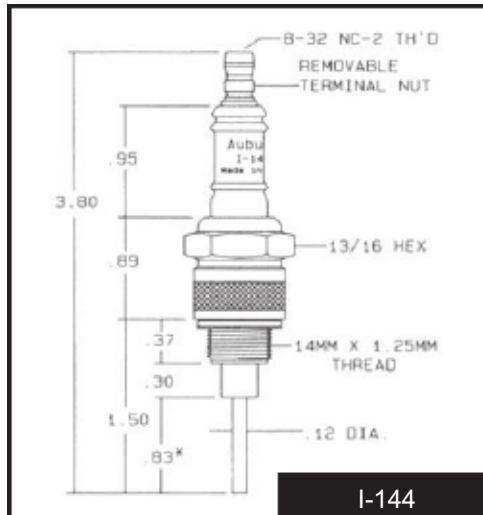

I-144

<input checked="" type="checkbox"/> No.	Ref. No.
E5-I-144	I-144

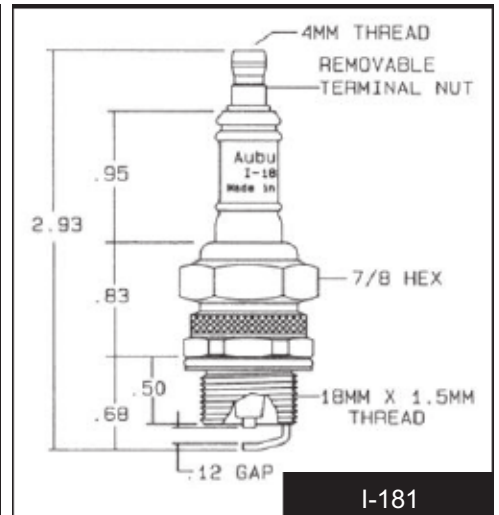

I-181

<input checked="" type="checkbox"/> No.	Ref. No.
E5-I-181	I-181

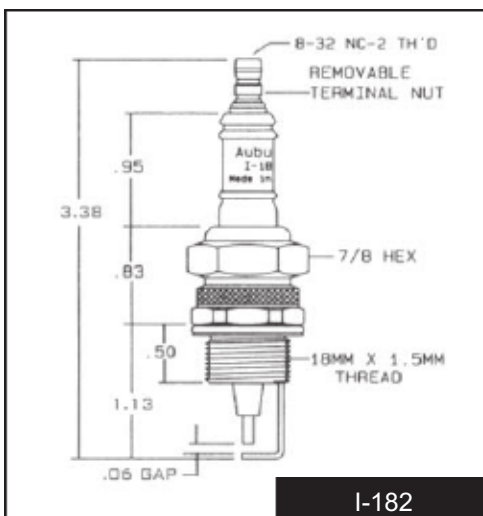

I-182

<input checked="" type="checkbox"/> No.	Ref. No.
E5-I-182	I-182

As a major distributor of Auburn Ignition Products, Westwood can special order any Auburn item not shown in this catalog and get it to you fast!

* Dimensions marked with an asterisk are standard lengths - Other lengths available upon request

AUBURN ELECTRODES

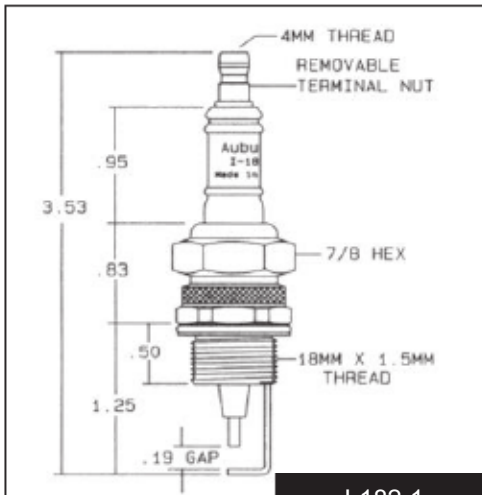

I-182-1

<input checked="" type="checkbox"/> No.	Ref. No.
E5-I-182-1	I-182-1

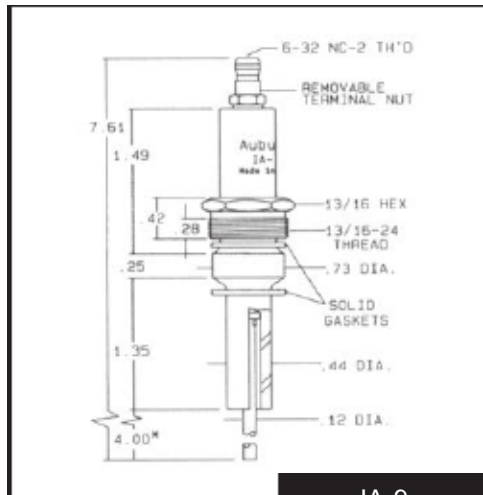

IA-9

<input checked="" type="checkbox"/> No.	Ref. No.
E5-IA-9	IA-9

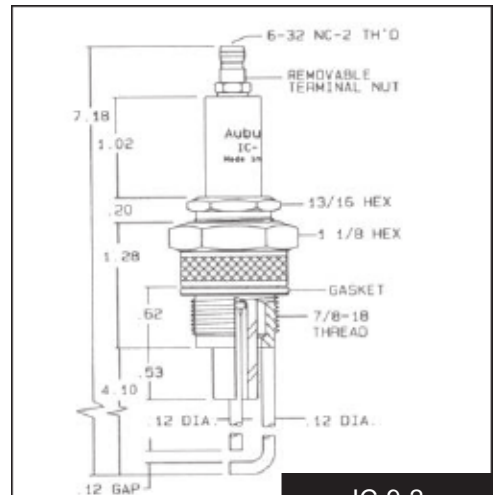

IC-9-2

<input checked="" type="checkbox"/> No.	Ref. No.
E5-IC9-2	IC9-2

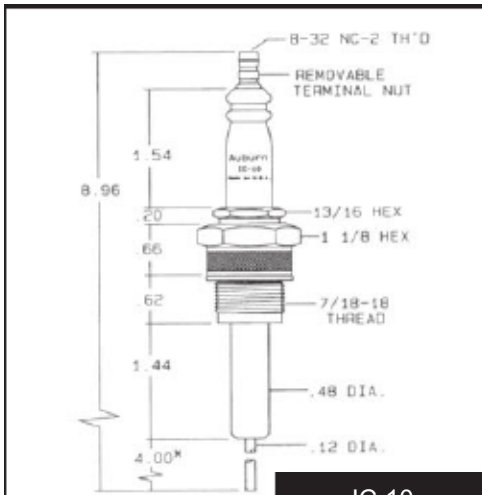

IC-10

<input checked="" type="checkbox"/> No.	Ref. No.
E5-IC-10	IC-10

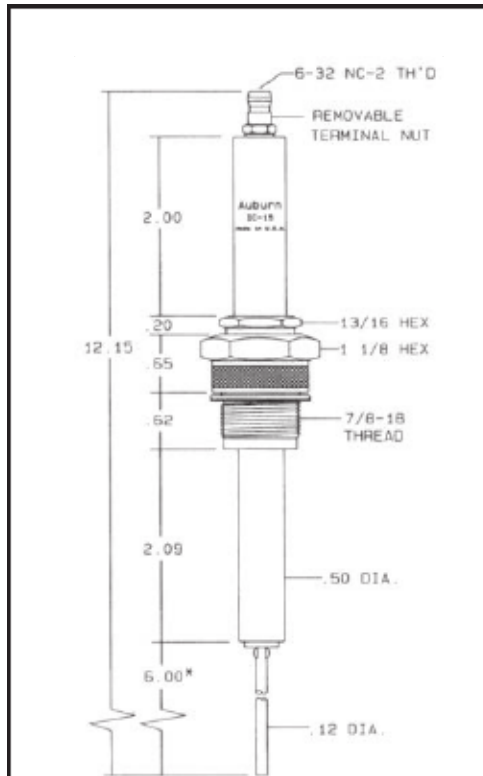

IC-15

<input checked="" type="checkbox"/> No.	Ref. No.
E5-IC-15	IC-15

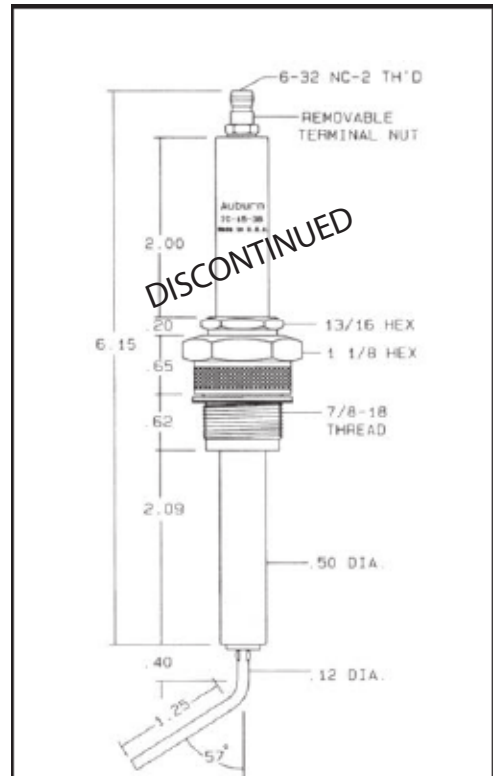

CHROMEL "D" Center Wire

IC-15-3B

<input checked="" type="checkbox"/> No.	Ref. No.
E5-IC-15-3B	IC-15-3B

As a major distributor of Auburn Ignition Products, Westwood can special order any Auburn item not shown in this catalog and get it to you fast!

* Dimensions marked with an asterisk are standard lengths - Other lengths available upon request

Please order by No.

AUBURN ELECTRODES

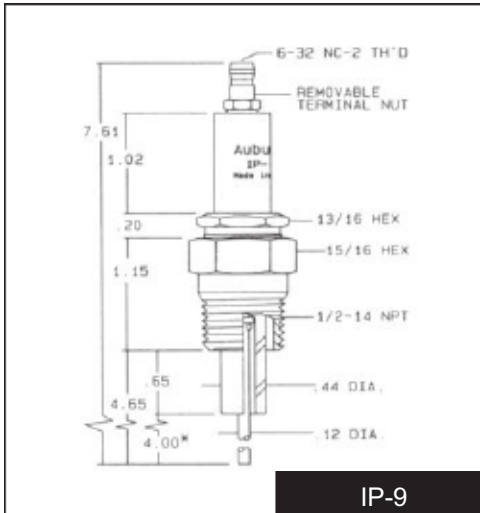

IP-9

<input checked="" type="checkbox"/> No.	Ref. No.
E5-IP-9	IP-9

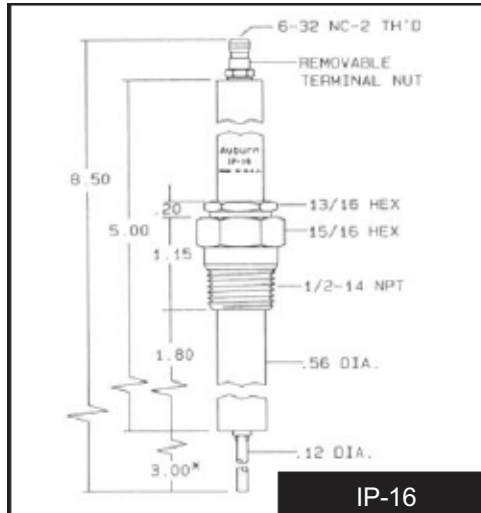

IP-16

<input checked="" type="checkbox"/> No.	Ref. No.
E5-IP-16	IP-16

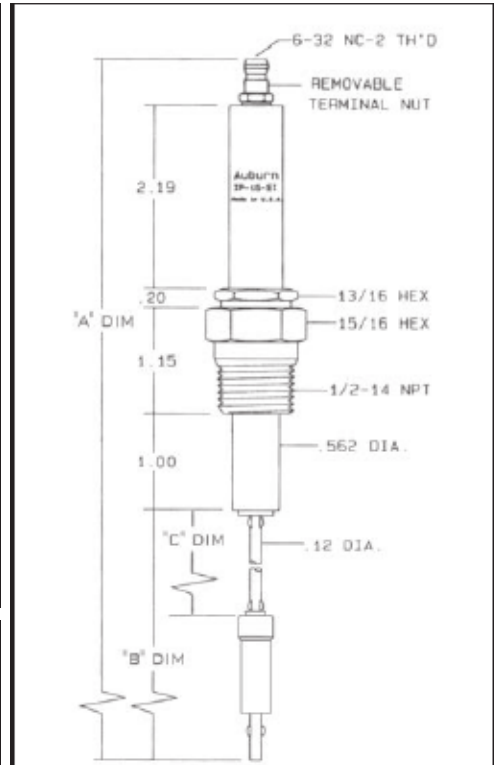

IP-16-EI Series

<input checked="" type="checkbox"/> No.	Ref. No.	"A"	"B"	"C"
E5-IP-16-EI	IP-16-EI	18.75	13.25	11.25

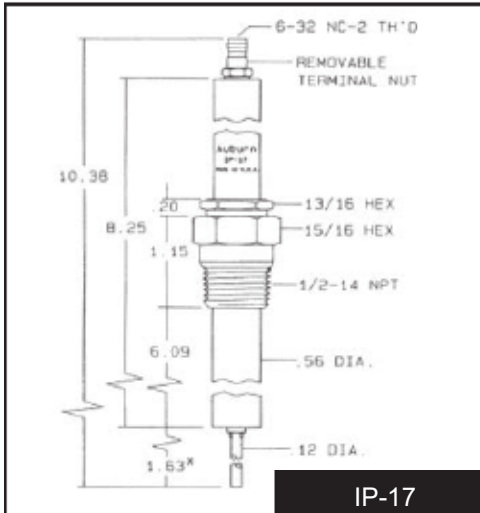

IP-17

<input checked="" type="checkbox"/> No.	Ref. No.
E5-IP-17	IP-17

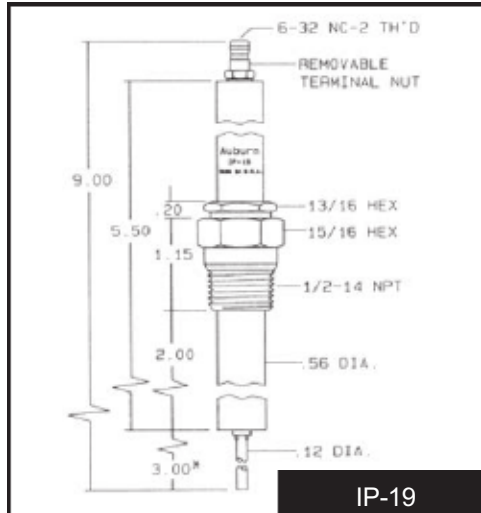

IP-19

<input checked="" type="checkbox"/> No.	Ref. No.
E5-IP-19	IP-19

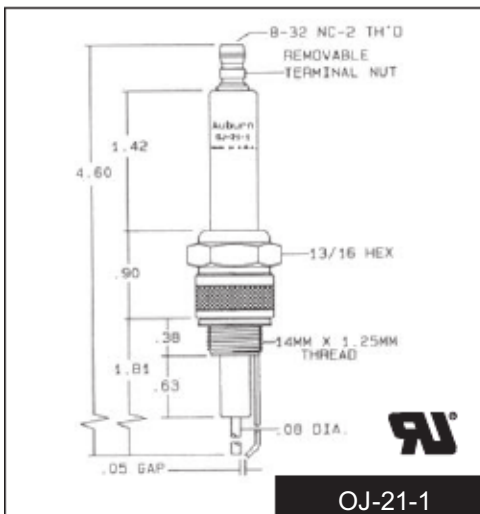

OJ-21-1

<input checked="" type="checkbox"/> No.	Ref. No.
E5-OJ-21-1	OJ-21-1

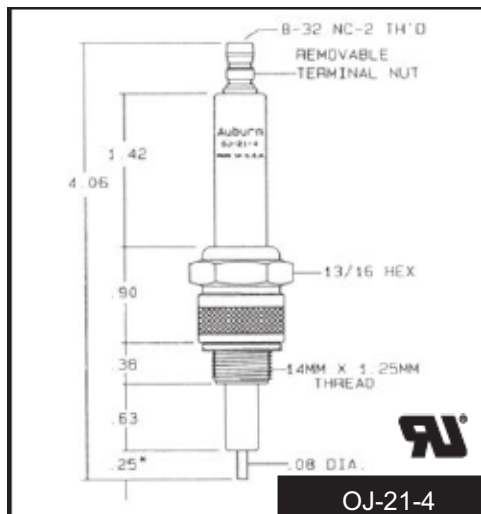

OJ-21-4

<input checked="" type="checkbox"/> No.	Ref. No.
E5-OJ-21-4	OJ-21-4

As a major distributor of Auburn Ignition Products, Westwood can special order any Auburn item not shown in this catalog and get it to you fast!

* Dimensions marked with an asterisk are standard lengths - Other lengths available upon request

AUBURN ELECTRODES & FLAME RODS

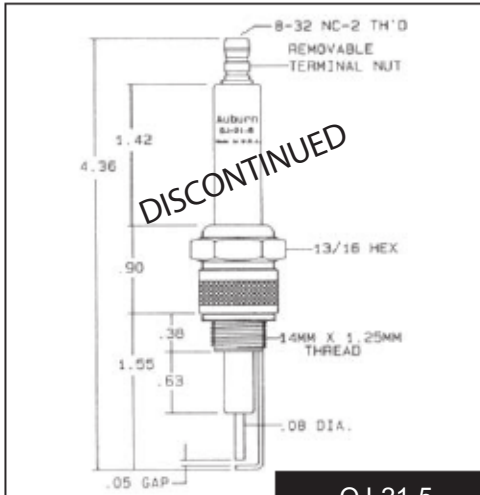

OJ-21-5

<input checked="" type="checkbox"/> No.	Ref. No.
E5-OJ-21-5	OJ-21-5

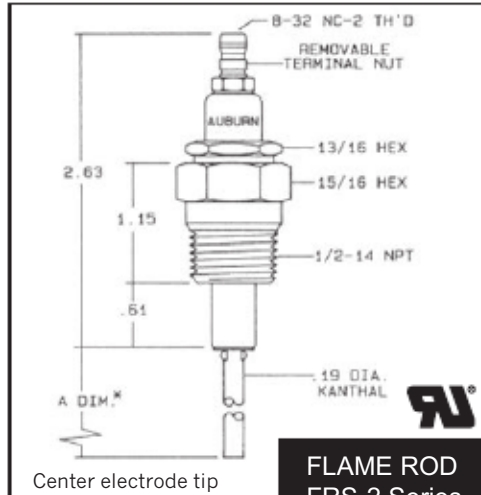

Center electrode tip operating temp 2,350° F

FLAME ROD FRS-2 Series

<input checked="" type="checkbox"/> No.	Ref. No.	"A" DIM.
E5-FRS-2-6	FRS-2-6	6"
E5-FRS-2-12	FRS-2-12	12"
E5-FRS-2-18	FRS-2-18	18"
E5-FRS-2-24	FRS-2-24	24"

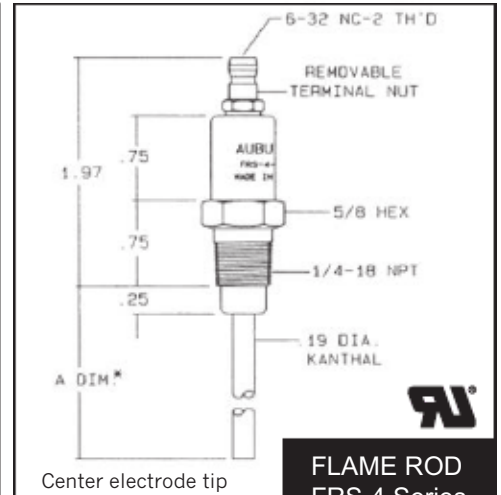

Center electrode tip operating temp 2,350° F

FLAME ROD FRS-4 Series

<input checked="" type="checkbox"/> No.	Ref. No.	"A" DIM.
E5-FRS-4-4	FRS-4-4	4"
E5-FRS-4-6	FRS-4-6	6"
E5-FRS-4-7-1/2	FRS-4-7-1/2	7-1/2"
E5-FRS-4-12	FRS-4-12	12"
E5-FRS-4-24	FRS-4-24	24"

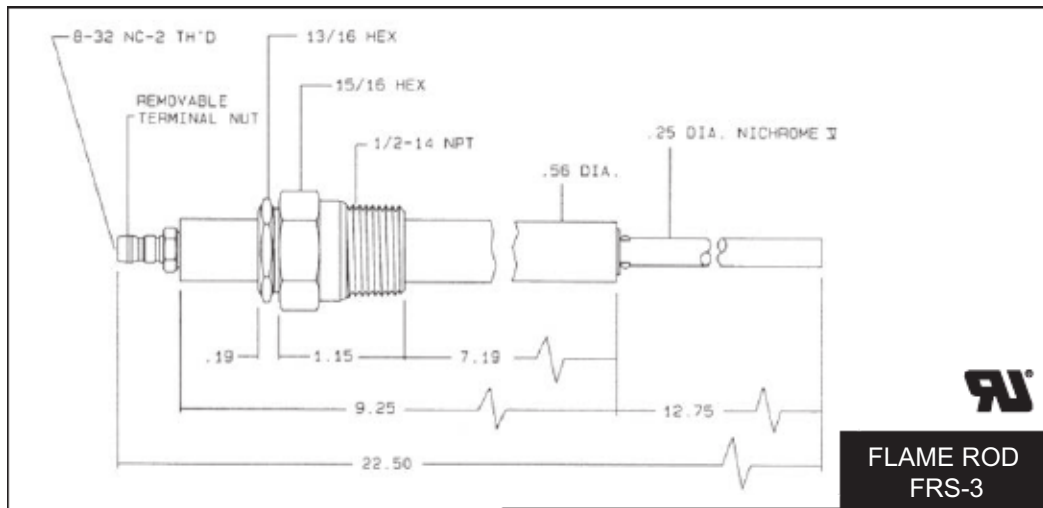

FLAME ROD FRS-3

<input checked="" type="checkbox"/> No.	Ref. No.
E5-FRS-3	FRS-3

As a major distributor of Auburn Ignition Products, Westwood can special order any Auburn item not shown in this catalog and get it to you fast!

* Dimensions marked with an asterisk are standard lengths - Other lengths available upon request

Please order by No.

AUBURN LIQUID LEVEL ELECTRODES

WCC Series:

Metal parts are 303 or 304 non-magnetic stainless steel. Incorporates an internal conductive glass seal (not recommended for use above 450 volts). Non-steam applications up to 2,500 PSI at 120° F or 0 PSI at 700° F. Steam applications up to 250 PSI at 406° F

WCC-KH Series:

Metal parts are 303 or 304 non-magnetic stainless steel. Incorporates a special insulator tip seal and Kovar center wire-glass seal. Non-steam applications up to 2,500 PSI at 120° F or 0 PSI at 450° F. Steam applications up to 450 PSI at 459° F

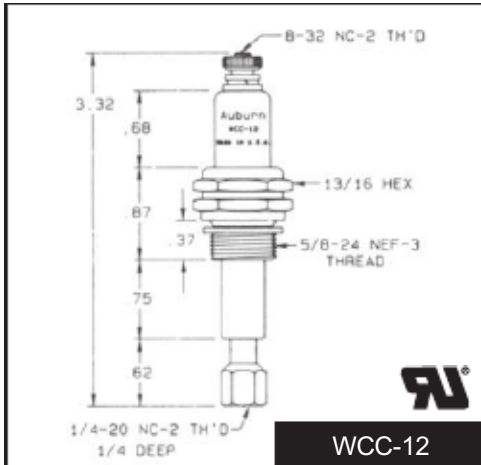

WCC-12

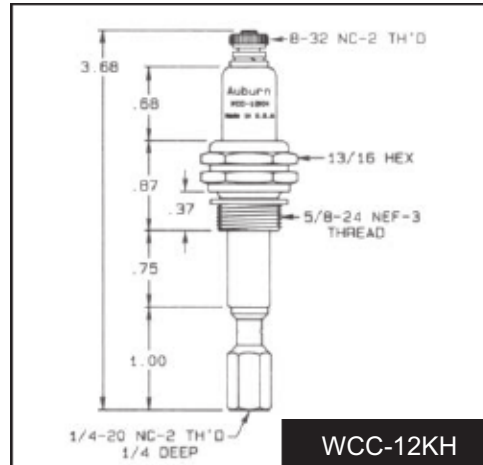

WCC-12KH

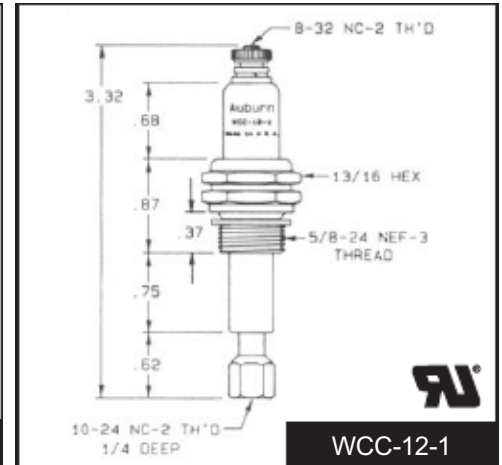

WCC-12-1

<input checked="" type="checkbox"/> No.	Ref. No.
E5-WCC-12	WCC-12

<input checked="" type="checkbox"/> No.	Ref. No.
E5-WCC-12KH	WCC-12KH

<input checked="" type="checkbox"/> No.	Ref. No.
E5-WCC-12-1	WCC-12-1

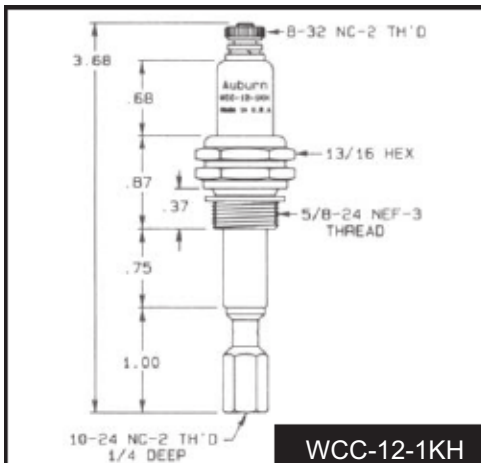

WCC-12-1KH

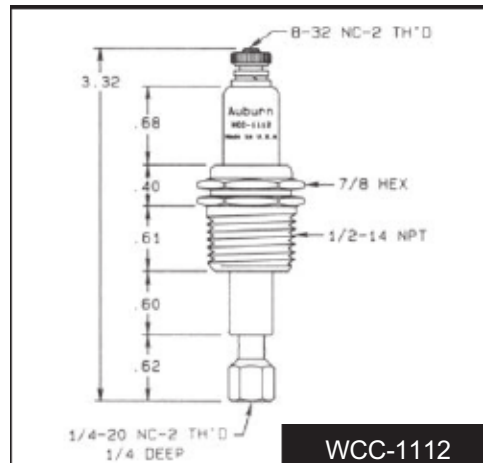

WCC-1112

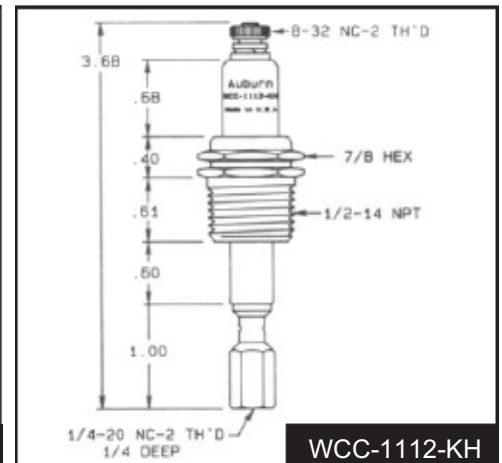

WCC-1112-KH

<input checked="" type="checkbox"/> No.	Ref. No.
E5-WCC-12-1KH	WCC-12-1KH

<input checked="" type="checkbox"/> No.	Ref. No.
E5-WCC-1112	WCC-1112

<input checked="" type="checkbox"/> No.	Ref. No.
E5-WCC-1112-KH	WCC-1112-KH

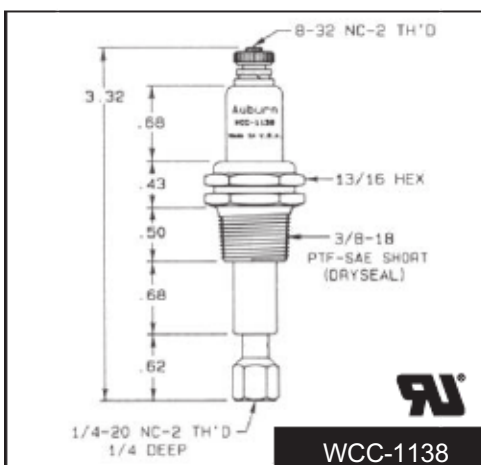

WCC-1138

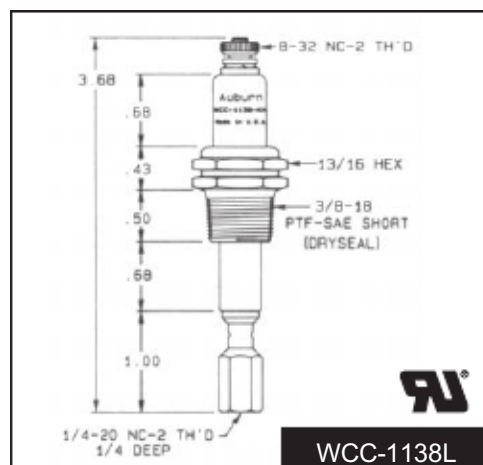

WCC-1138L

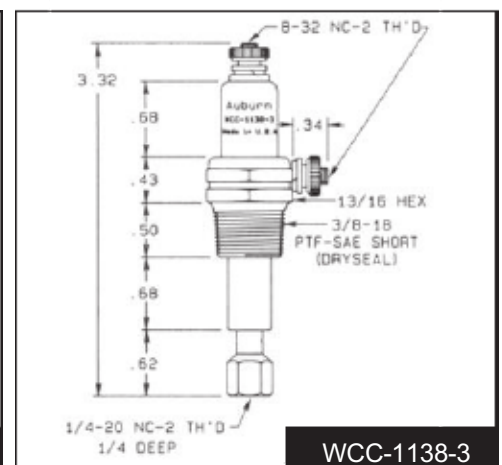

WCC-1138-3

<input checked="" type="checkbox"/> No.	Ref. No.
E5-WCC-1138	WCC-1138

<input checked="" type="checkbox"/> No.	Ref. No.
E5-WCC-1138L	WCC-1138L

<input checked="" type="checkbox"/> No.	Ref. No.
E5-WCC-1138-3	WCC-1138-3

AUBURN LIQUID LEVEL ELECTRODES

WCT Series:

Metal parts are 303 or 304 non-magnetic stainless steel, center electrodes are one piece.

Non-steam applications up to 1,000 PSI at 120° F or 0 PSI at 400° F

Steam applications up to 100 PSI at 337° F

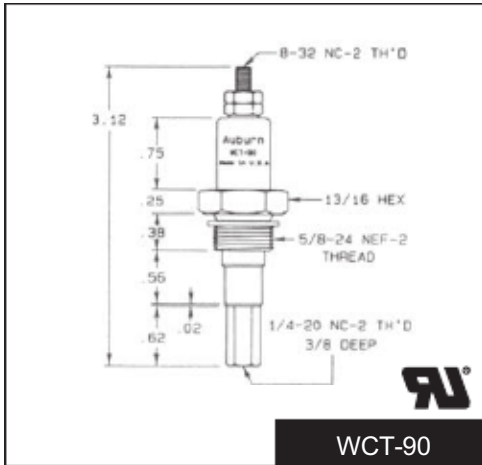

WCT-90

<input checked="" type="checkbox"/> No.	Ref. No.
E5-WCT-90	WCT-90

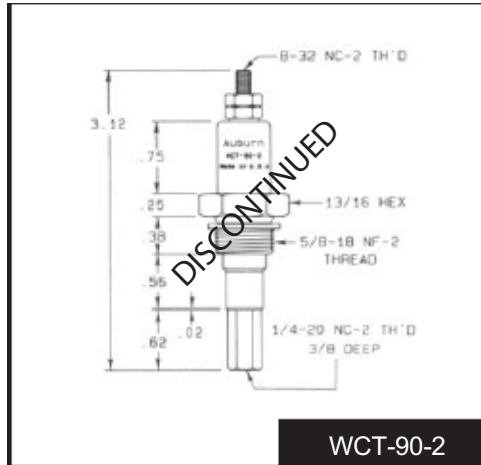

WCT-90-2

<input checked="" type="checkbox"/> No.	Ref. No.
E5-WCT-90-2	WCT-90-2

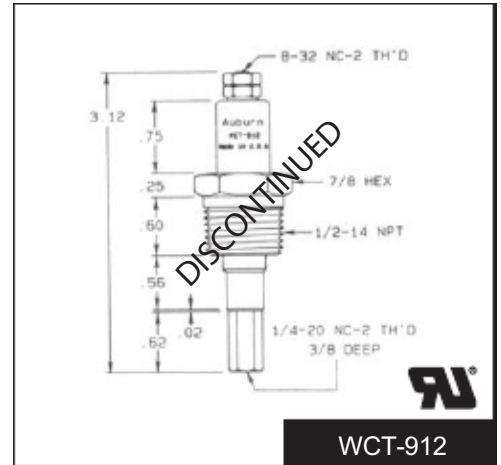

WCT-912

<input checked="" type="checkbox"/> No.	Ref. No.
E5-WCT-912	WCT-912

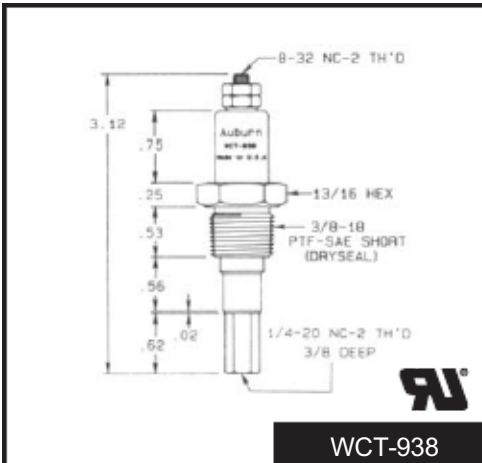

WCT-938

<input checked="" type="checkbox"/> No.	Ref. No.
E5-WCT-938	WCT-938

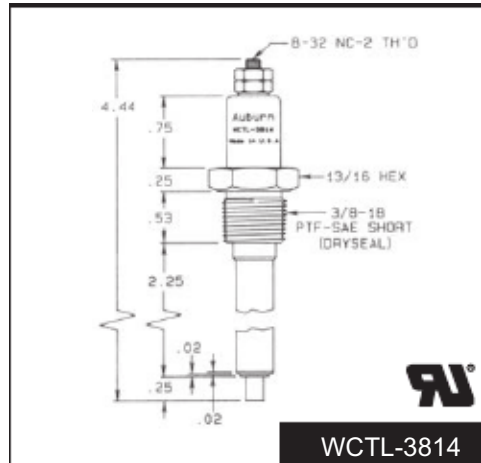

WCTL-3814

<input checked="" type="checkbox"/> No.	Ref. No.
E5-WCTL-3814	WCTL-3814

As a major distributor of Auburn Liquid Level Electrodes, Westwood can special order any Auburn item not shown in this catalog and get it to you fast!



LIQUID LEVEL PROBES for FULTON BOILERS on page H9

Please order by No.

Westwood

SOLID STAINLESS STEEL PROBES

FOR USE ON LIQUID LEVEL ELECTRODE ASSEMBLIES

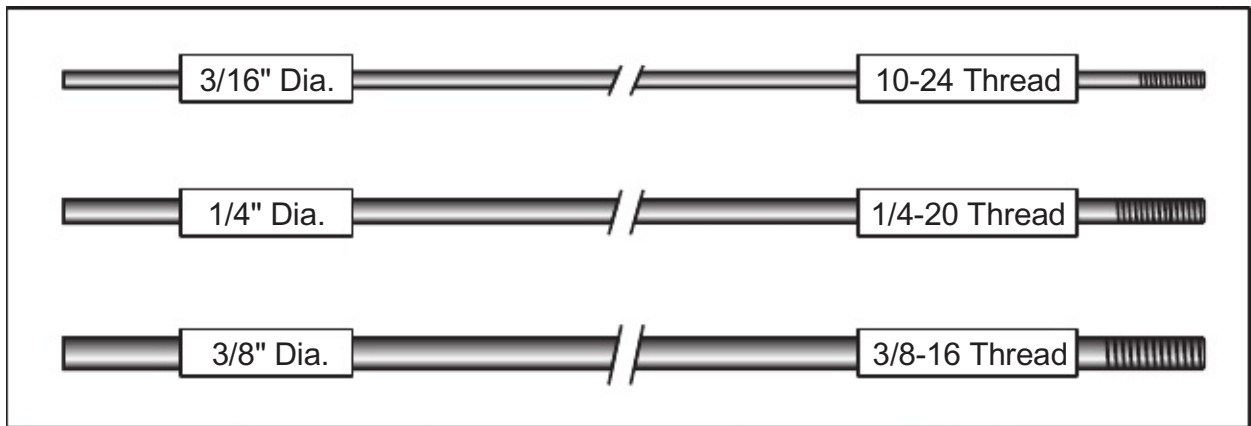

STANDARD SIZES*

 No.	Ref. No.	Thread	Length	Diameter
E5-1024-12	1024-12	10-24	12"	3/16"
E5-1024-18	1024-18	10-24	18"	3/16"
E5-1024-24	1024-24	10-24	24"	3/16"
E5-1420-6	1420-6	1/4-20	6"	1/4"
E5-1420-12	1420-12	1/4-20	12"	1/4"
E5-1420-18	1420-18	1/4-20	18"	1/4"
E5-1420-24	1420-24	1/4-20	24"	1/4"
E5-1420-36	1420-36	1/4-20	36"	1/4"
E5-3816-12	3816-12	3/8-16	12"	3/8"
E5-3816-18	3816-18	3/8-16	18"	3/8"
E5-3816-24	3816-24	3/8-16	24"	3/8"

**Made to order non-standard lengths available by special order.*



Take a look ...

LIQUID LEVEL PROBES for
FULTON BOILERS on page H9

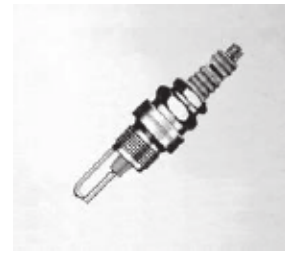

NOTE: Champion ignition assembly part numbers are now " E5- " followed by the former number.

Example:

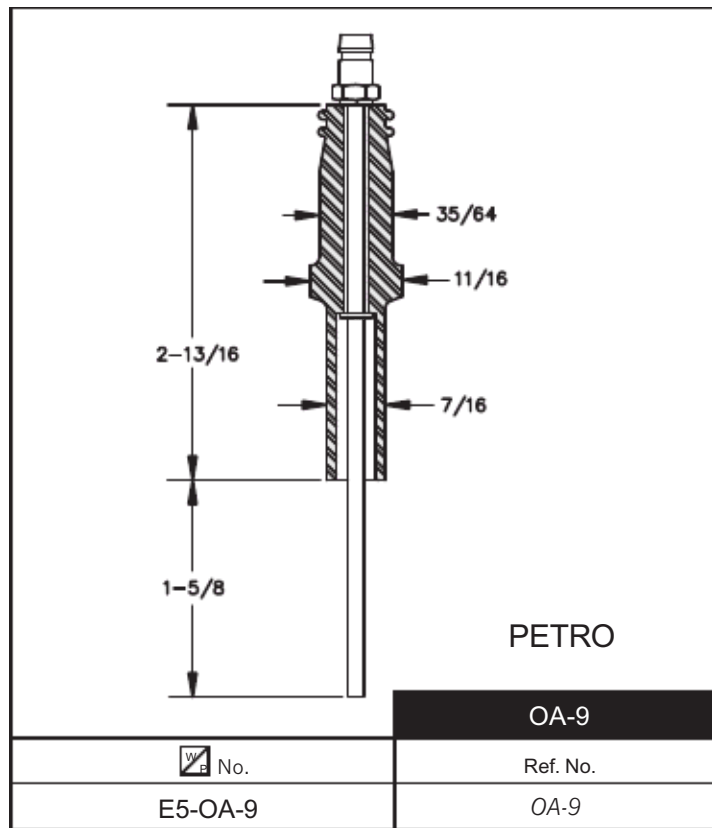
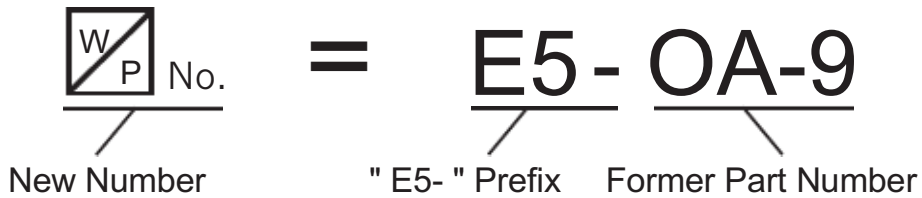

Westwood

CHAMPION

IGNITION ASSEMBLIES



14 MM

A-25

<input checked="" type="checkbox"/> No.	Ref. No.
E5-A-25	A-25



14 MM

CJ-8

<input checked="" type="checkbox"/> No.	Ref. No.
E5-CJ-8	CJ-8



2.98"

$\frac{17}{32}$

14 MM

D-9

<input checked="" type="checkbox"/> No.	Ref. No.
E5-D-9	D-9



3.22"

1"

18 MM x 1.25MM

D-89D

<input checked="" type="checkbox"/> No.	Ref. No.
E5-D-89D	D-89D



14 MM x 1.25MM

H14Y

<input checked="" type="checkbox"/> No.	Ref. No.
E5-H14Y	H14Y

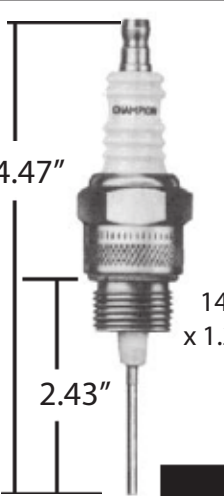

4.47"

2.43"

14 MM x 1.25MM

J-99

<input checked="" type="checkbox"/> No.	Ref. No.
E5-J-99	J-99



18 MM x 1.25MM

K97F

<input checked="" type="checkbox"/> No.	Ref. No.
E5-K97F	K97F

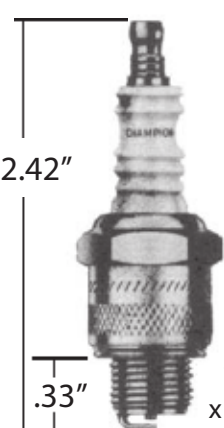

2.42"

.33"

10 MM x 1.0 MM

UY-6

<input checked="" type="checkbox"/> No.	Ref. No.
E5-UY-6	UY-6



7/8-18 THD

W18

<input checked="" type="checkbox"/> No.	Ref. No.
E5-W18	W18

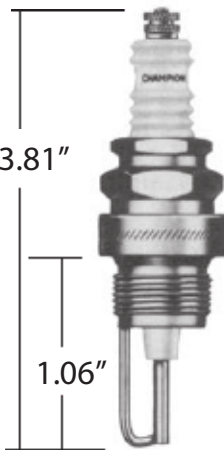

3.81"

1.06"

7/8-18 THD

W-95D

<input checked="" type="checkbox"/> No.	Ref. No.
E5-W-95D	W-95D

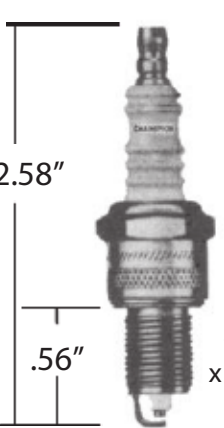

2.58"

.56"

10MM x 1.0MM

Z-6

<input checked="" type="checkbox"/> No.	Ref. No.
E5-Z-6	Z-6



TERMINALS



SPECIAL NOTE: NEW ~~Rajah~~ TERMINAL PART NUMBERS
Rajah terminals and related items part numbers are now " E9- " followed by the former part number.

Example:

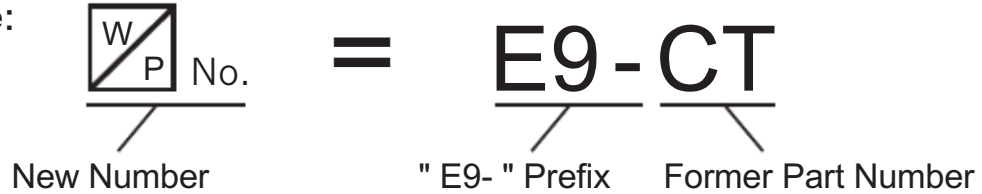

Note: Terminal part number endings of 6-32, 8-32, 10-24, and 10-32 refer to terminal thread size

 No. E9-CT	 No. E9-SS	 No. E9-R-2	 No. E9-SF	 No. E9-TT
 No. E9-CT-TS 8-32 E9-CT-TS 10-32	 No. E9-SS-TS 10-32	 No. E9-SR	 No. E9-HS 6-32 E9-HS 10-32	 No. E9-CT-BS 6-32 E9-CT-BS 8-32 E9-CT-BS 10-32
 No. E9-SS-BS 6-32 E9-SS-BS 8-32 E9-SS-BS 10-32	 No. E9-HT 6-32 E9-HT 8-32 E9-HT 10-32	 No. E9-SX-1 6-32 E9-SX-1 10-32	 No. E9-CT-SS	 No. E9-ACT
 No. E9-ASS	 No. E9-CHT	 No. E9-BS 6-32 E9-BS 8-32 E9-BS 10-24 E9-BS 10-32	 No. E9-458-9 10-32	 No. E9-RAC
 No. E9-RASS	 No. E9-EBS 6-32 E9-EBS 10-32	 No. E9-457-6 6-32	 No. E9-SS-SOS	 No. E9-R-SOS



























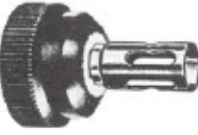
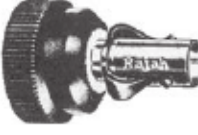

Please order by No.



TERMINALS

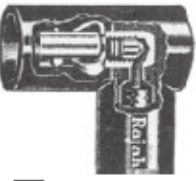
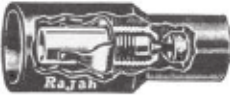

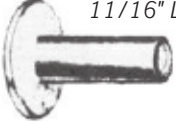
Note: Terminal part number endings of 6-32, 8-32, 10-24, and 10-32 refer to terminal thread size

 <input checked="" type="checkbox"/> No. E9-T-SOS	 <input checked="" type="checkbox"/> No. E9-AS-SOS	 <input checked="" type="checkbox"/> No. E9-BS-SOS	 <input checked="" type="checkbox"/> No. E9-SSN	 <input checked="" type="checkbox"/> No. E9-RSN
 <input checked="" type="checkbox"/> No. E9-TSN	 <input checked="" type="checkbox"/> No. E9-ASN	 <input checked="" type="checkbox"/> No. E9-BSN	 <input checked="" type="checkbox"/> No. E9-ACT-BS 6-32 E9-ACT-BS 10-32	 <input checked="" type="checkbox"/> No. E9-DS-1
 <input checked="" type="checkbox"/> No. E9-FF-1	 <input checked="" type="checkbox"/> No. E9-CC-1	 <input checked="" type="checkbox"/> No. E9-SS-LBS	 <input checked="" type="checkbox"/> No. E9-SS-LTS	 <input checked="" type="checkbox"/> No. E9-XC
 <input checked="" type="checkbox"/> No. E9-SA-1 6-32	 <input checked="" type="checkbox"/> No. E9-ITN 8-32 E9-ITN 10-32	 <input checked="" type="checkbox"/> No. E9-ITN-S 6-32 E9-ITN-S 8-32	 <input checked="" type="checkbox"/> No. E9-TC-10	 <input checked="" type="checkbox"/> No. E9-TS-10
 <input checked="" type="checkbox"/> No. E9-R-1	 <input checked="" type="checkbox"/> No. E9-RS-3 10-32	 <input checked="" type="checkbox"/> No. E9-RX-4 6-32 E9-RX-4 8-32 E9-RX-4 10-32	 <input checked="" type="checkbox"/> No. E9-RX-5 10-32	 <input checked="" type="checkbox"/> No. E9-RP-6
 <input checked="" type="checkbox"/> No. E9-RC-5	 <input checked="" type="checkbox"/> No. E9-RE-7	 <input checked="" type="checkbox"/> No. E9-AEBF	 <input checked="" type="checkbox"/> No. E9-EBF	 <input checked="" type="checkbox"/> No. E9-B-10 10-32
 <input checked="" type="checkbox"/> No. E9-B-11 10-32	 <input checked="" type="checkbox"/> No. E9-BC-11	 <input checked="" type="checkbox"/> No. E9-BS-12		



TERMINALS



Note: Terminal part number endings of 6-32, 8-32, 10-24, and 10-32 refer to terminal thread size

<p><i>Rockett</i></p> <p>DISCONTINUED USE E9-Y5-10</p> <p><input checked="" type="checkbox"/> No. E9-S-15 10-32</p>	<p><input checked="" type="checkbox"/> No. E9-AL-10</p>	<p><input checked="" type="checkbox"/> No. E9-AS-10</p>	<p><input checked="" type="checkbox"/> No. E9-ASC</p>	<p><input checked="" type="checkbox"/> No. E9-S-10</p>
<p><input checked="" type="checkbox"/> No. E9-CS</p>	<p><input checked="" type="checkbox"/> No. E9-YL-10</p>	<p><input checked="" type="checkbox"/> No. E9-Y5-10</p>	<p><input checked="" type="checkbox"/> No. E9-YSC</p>	<p>1-1/8" Long</p> <p><input checked="" type="checkbox"/> No. E9-SCS-2 6-32</p>
<p>1-1/4" Long</p> <p><input checked="" type="checkbox"/> No. E9-SCS-1 10-32</p>	<p><input checked="" type="checkbox"/> No. E9-KBN 6-32 E9-KBN 10-24</p>	<p><input checked="" type="checkbox"/> No. E9-DT</p>	<p>Cleaver Brooks Spring Connects plate assembly to ignitors - 20" Long</p> <p><input checked="" type="checkbox"/> No. E9-CBS</p>	

SPECIALTY TERMINAL & ELECTRODE HARDWARE

<p>1-1/2"</p> <p>Walter Kidde brass buss bar</p> <p><input checked="" type="checkbox"/> No. E9-686 BAR</p>	<p>3/4" O.D. 9/16" I.D.</p> <p>7/16"</p> <p>Beveled and split brass bushing</p> <p><input checked="" type="checkbox"/> No. E9-BB</p>	<p>1/2" O.D. 7/16" I.D.</p> <p>7/16"</p> <p>Zinc plated split steel bushing</p> <p><input checked="" type="checkbox"/> No. E9-PB</p>	<p>9/16" O.D. 7/16" I.D.</p> <p>3/4"</p> <p>Zinc plated split steel bushing</p> <p><input checked="" type="checkbox"/> No. E9-AB</p>	<p>5/8" O.D. 9/16" I.D.</p> <p>1"</p> <p>Zinc plated split steel bushing</p> <p><input checked="" type="checkbox"/> No. E9-DB</p>
<p>3/4" O.D. - 9/16" I.D. 1/16" Thick</p> <p>Cleaver Brooks split ring zinc plated steel</p> <p><input checked="" type="checkbox"/> No. E9-CBR</p>	<p>3/4" O.D. - 9/16" I.D. 1/16" Thick</p> <p>Copper gasket - dished</p> <p><input checked="" type="checkbox"/> No. E9-467 GASKET</p>	<p>3/4" O.D. - 9/16" I.D. 1/32" Thick</p> <p>Copper gasket - flat</p> <p><input checked="" type="checkbox"/> No. E9-I-18 GASKET</p>	<p>19/32" I.D. 3/4" O.D.</p> <p>1"</p> <p>Black bakelite shield for Ray</p> <p><input checked="" type="checkbox"/> No. E9-500 SHIELD</p>	

BUSS BARS

<input checked="" type="checkbox"/> No.	Ref. No.	12" Length*
E9-TYPE ET	Type ET	Round brass with eyelet and 6-32 thread
E9-TYPE F	Type F	Flat brass with 1/8" hole
E9-TYPE ST	Type ST	Round brass with 6-32 thread

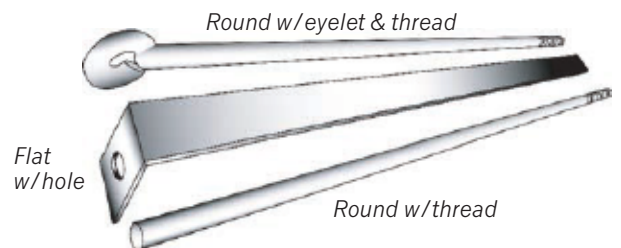



* Other lengths available up to 24"

Please order by No.

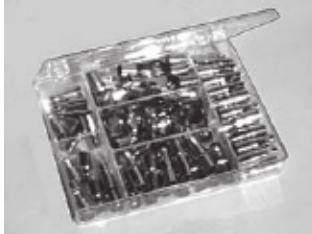

IGNITION TERMINAL KITS



 No.	Ref. No.	Description
E9-34	34	Rajah™ "Mini" Ignition Terminal Kit:
		20 - CT Cage Terminals 12 - SS Spring Snap Terminals 20 - R2 Ring Terminals 10 - RAC Right Angle Cage Terminals 12 - SF Stud Ferrule Terminals
E9-54	54	Rajah™ Transformer Terminal Kit:
		6 - AS-10 Short Adapter Spring 6 - AL-10 Long Adapter Spring 2 - STS-10 Thumb Nut on Cage 2 - 458-9 Spring Plunger (10-32) 4 - B-10 Button Contact (short) 2 - B-11 Button Contact (long) 6 - CC-1 Cage on Cage 6 - RC-5 Ram's Horn on Cage 4 - RX4 Ram's Horn on Hex 2 - R1 Ram's Horn Clip 6 - HS Hollow Stud (10-32) 6 - SX Hex Stud (10-32)
E9-2097	2097	Rajah™ "Pro" Ignition Terminal Kit:
		24 - CT Cage Terminals 24 - SS Spring Snap Terminals 24 - R2 Ring Terminals 24 - SF Stud Ferrule Terminals 24 - RAC Right Angle Cage Terminals 100 - DT Distributor Terminals 24 - FF-1 Ferrule on Ferrule 1 - T200-10 (former #695) Terminal Crimping Tool
E9-3500	3500	Rajah™ "Deluxe" Ignition Terminal Kit:
		12 - CT Cage Terminals 12 - SS Spring Snap Terminals 12 - R2 Ring Terminals 12 - ACT Angle Cage Terminals 12 - SF Stud Ferrule Terminals 12 - BS Base Stud (6-32) 12 - BS Base Stud (10-32) 12 - HS Hollow Stud (6-32) 12 - HS Hollow Stud (10-32) 12 - CC-1 Cage on Cage 12 - CT-TS Cage on Stud (10-32) 12 - RC-5 Ram's Horn on Cage 12 - R-1 Ram's Horn Clip 12 - #299 Special GE Slotted Stud 12 - SX Hex Stud (10-32) 1 - 1/4" Nut Driver 1 - 5/16" Nut Driver 1 - T200-10 (former #695) Terminal Crimping Tool
E9-CK-1	CK-1	Rajah™ Carlin Transformer Contact Kit:
		For in the field conversion on Carlin Burner models 98, 99, 100, 101, 102 Webster transformer model 313-28AB85 2 - Contact clips 2 - Flat washers (#10) 2 - Shakeproof washers (#10) 2 - 10-32 nuts

ELECTRICAL CLIPS & RUBBER BOOTS

 <p><input checked="" type="checkbox"/> No. E9-LV CLIP</p>	<p>Vinyl</p>  <p><input checked="" type="checkbox"/> No. E9-LV BOOT</p>	 <p><input checked="" type="checkbox"/> No. E9-20 AMP CLIP</p>	<p>Vinyl</p>  <p><input checked="" type="checkbox"/> No. E9-20 AMP BOOT</p>
<p>Distributor nipple</p>  <p><input checked="" type="checkbox"/> No. E9-DN</p>	<p>Silicone Rubber</p>  <p><input checked="" type="checkbox"/> No. E9-250 BOOT</p>	<p>Silicone Rubber</p>  <p><input checked="" type="checkbox"/> No. E9-251 BOOT</p>	



Take a look ...

JUMPERS & CORD CLIP SETS on page T13

HIGH TEMPERATURE CERAMIC SPARK PLUG BOOTS with Stainless Steel Terminals

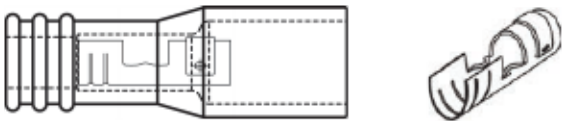
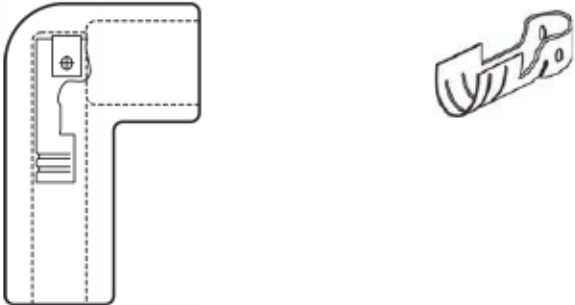
<input checked="" type="checkbox"/> No.	Ref. No.	Description
E9-ECF	ECF	<p>EXTENDED CERAMIC BOOT - with stainless steel terminal for 7mm ignition wire</p> 
E9-AECF	AECF	<p>ANGLE EXTENDED CERAMIC BOOT - with stainless steel terminal for 7mm ignition wire</p> 

Westwood IGNITION CABLE

Cable Type	UL LISTED	W/P No.		
		25' Roll	100' Roll	1,000' Roll
GTO-15	Yes	E60-25	E60-100	E60-1000
White Silicone	-	E62-25	E62-100	-
Red Silicone	Yes	E63-25	E63-100	E63-1000

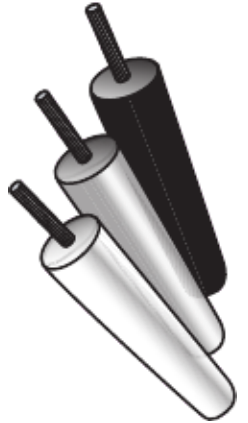

GTO-15 (black)	<p>Large .275" outside diameter fits Rajah terminals perfectly. Withstands more than 15,000 VAC with low current leakage. Resists arc-over, tracking, and burning. Tested to withstand conditions of heat, oil, and moisture. No. 14 gauge, 19 x 26 stranded tinned copper wire. All vinyl insulation affords low temperature flexibility. Flame retardant, will not support combustion. Tough and abrasion resistant, yet easy stripping. Temperature range: UL LISTED to 105° C (221° F)</p>
White Silicone	<p>Large .275" outside diameter fits Rajah terminals perfectly. Withstands more than 10,000 VAC and 25,000 VDC with low current leakage. No. 16 gauge, 19 x 26 stranded tinned copper wire. Natural Silicone insulation, high dielectric strength. Temperature range: -65° F to 400° F (-54° C to 204° C)</p>
Red Silicone	<p>Large .275" outside diameter fits Rajah terminals perfectly. Withstands more than 10,000 VAC and 25,000 VDC with low current leakage. No. 16 gauge, 19 x 26 stranded nickel plated copper wire. Natural Silicone insulation, high dielectric strength. Temperature range: -65° F to 482° F (-54° C to 250° C) UL LISTED</p>

CABLE ASSEMBLIES and FIBERGLAS BRAID

W/P No.	Ref. No.	Description
E64	#3250	Red Silicone wire high temperature cable assembly with protective metal braid . Temperature range -65° F to 450° F. Overall length is 32-1/2".
E64-5	#RS-3350	Red Silicone wire high temperature cable assembly with red Silicone boots . Temperature range -65° F to 450° F. Withstands 10,000 VAC / 25,000 VDC . Overall length is 33-1/2".
E64-20	#3253	Fiberglass braided sleeving. Fits over ignition cable for high temperature protection. Sold by the foot. (Ordering example: For 5' of sleeving order 5 of E64-20. Shipped as one piece)

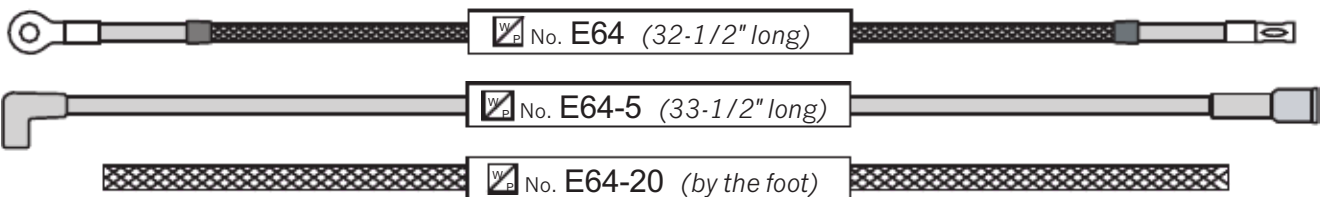

ELECTRICAL ACCESSORIES



SOLDERLESS TERMINAL KIT

No. **E70**

Contains 175 of the most popular terminals and connectors

KIT REFILL TERMINALS - Part numbers are for a package of the quantity indicated

 AWG: 22-16 Female .250 Tab No. E70-10	 AWG: 22-16 Ring #6 Stud No. E70-20	 AWG: 16-14 Ring #8 Stud No. E70-21	 AWG: 16-14 Spade #8 Stud No. E70-34	 AWG: 16-14 Spade #10 Stud No. E70-36	 AWG: 22-16 Butt Connector No. E70-40
BACK ROW - All Packages of 100					

 AWG: 16-14 Female .250 Tab No. E70-12	 AWG: 22-16 Ring #10 Stud No. E70-22	 AWG: 16-14 Ring #10 Stud No. E70-23	 AWG: 16-14 Spade #6 Stud No. E70-30	 AWG: 22-16 Spade #6 Stud No. E70-32	 AWG: 16-14 Butt Connector No. E70-42
MIDDLE ROW - Packages of 100					Pkg. of 50

 AWG: 12-10 Female .250 Tab No. E70-14	 AWG: 12-10 Ring #10 Stud No. E70-24	 AWG: 12-10 Ring 1/4" Stud No. E70-25	 AWG: 12-10 Ring 5/16" Stud No. E70-26	 AWG: 12-10 Spade #10 Stud No. E70-38	 AWG: 12-10 Butt Connector No. E70-44
FRONT ROW - All Packages of 50					

WIRE CONNECTORS - Part numbers are for a package of 100



	GREY	BLUE	ORANGE	YELLOW	RED
No.	E70-50	E70-52	E70-54	E70-56	E70-58

CABLE TIES - Part numbers are for a package of 100



	4"	5-1/2"	7-1/2"	11"	14-1/2"
No.	E70-60	E70-62	E70-64	E70-66	E70-68

ROUGH SERVICE BULBS

Part numbers are for a box of 2 bulbs



	75 Watt	100 Watt
No.	E70-75	E70-100



Please order by No.

Westwood

CAD CELL FLAME DETECTORS

UNIVERSAL REPLACEMENT FOR HONEYWELL AND WHITE-RODGERS

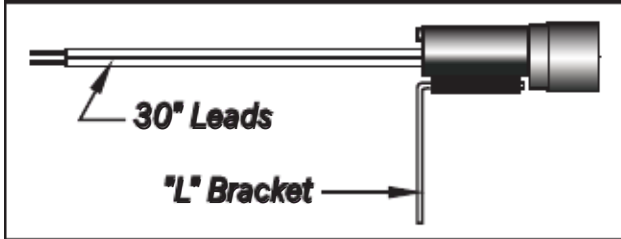

No. E80

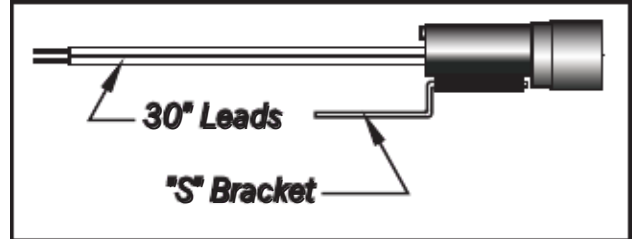

No. E80-1

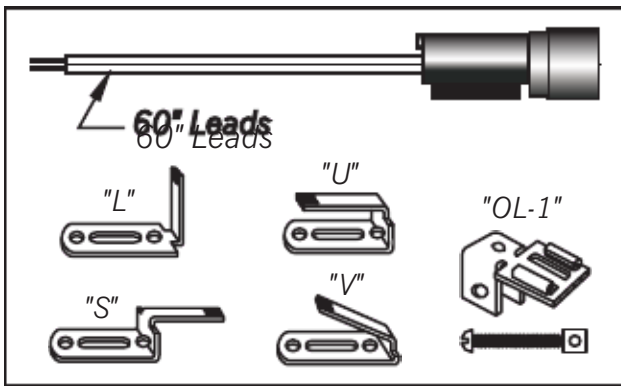

No. E80-2

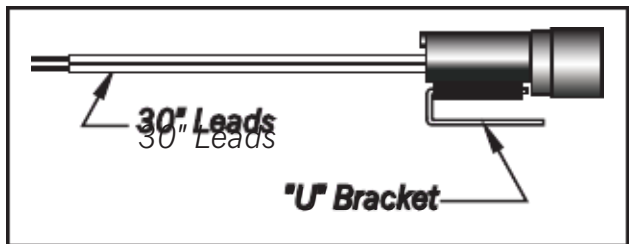

No. E80-3

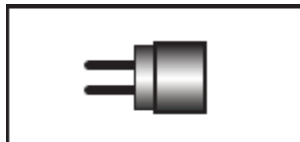

No. E81

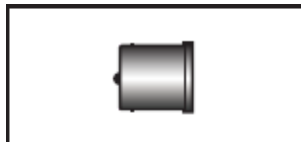

No. E81-10

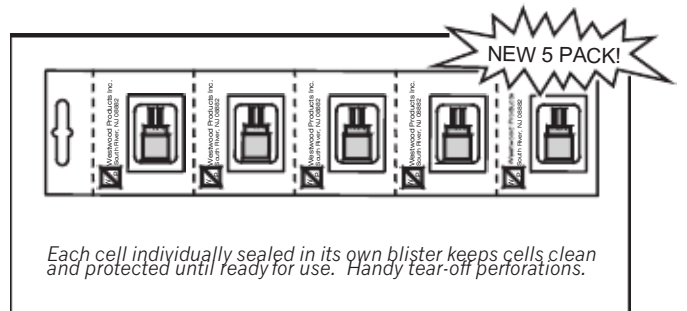

Each cell individually sealed in its own blister keeps cells clean and protected until ready for use. Handy tear-off perforations.

No. E81-5

No.	Ref. No.	Description
E80	TM-30L	Complete flame detector with cad cell eye*, 30" leads, "L" bracket, poly bag package
E80-1	TM-30S	Complete flame detector with cad cell eye*, 30" leads, "S" bracket, poly bag package
E80-2	TMK-60	Complete flame detector kit with cad cell eye*, 60" leads, "L" bracket, "S" bracket, "U" bracket, "V" bracket, "OL-1" special oil line bracket with mounting screw and nut, packaged in a box
E80-3	-	Complete flame detector with cad cell eye*, 30" leads, "U" bracket, poly bag package
E81	Type M	Cad cell eye* packaged in a box
E81-5	-	Cad cell eye* 5 pack (blister card with 5 E81-5 eyes per card), tear-off perforations
E81-10	Type W	Cad cell eye, bayonet mount for White-Rodgers cad cell flame detector, packaged in a box

* Cad cell eye replaces Honeywell 130367 and fits C554A flame detector



Take a look ...

T70 Cad cell relay and eye tester on page T11

THERMOSTAT GUARDS

METAL AND PLASTIC TAMPER PROOF DESIGNS IN PLEASING COLORS

Designed for use in schools, industrial plants and military installations where **rugged, maximum protection** is the first consideration. The louvered covers cannot be twisted or jammed open.

Bobby pins, pencils, letter openers and other such objects cannot be inserted through the cover to adjust the thermostat.

- ▶ Metal guards are constructed of 18-22 gauge steel with a baked enamel finish
- ▶ Plastic guards are molded from hi-impact plastic and can be used with both horizontally or vertically mounted thermostats
- ▶ All guards come with eight tumbler lock, one key, and mounting hardware
- ▶ Guards with ring bases can be installed without removing the thermostat



No. E140



No. E140-1

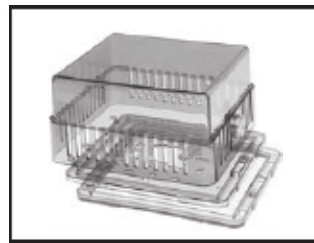

No. E141

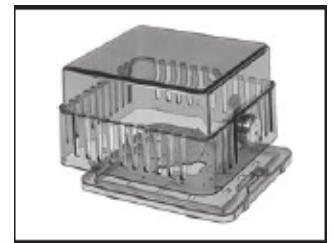

No. E142

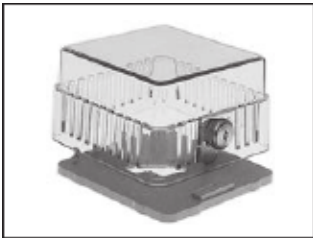

No. E142-1



No. E142-2



No. E142-3



No. E143

<input checked="" type="checkbox"/> No.	Ref. No.	Inside Dimensions H" x W" x D"	Mat'l	Color	Base	Comments
E140	WTG-54VL	6-1/4 x 4-3/4 x 3	M	BE	SH	T80, T90, T91, T199, T330, T340, T42, T26, T87, T92, T651, T921, T872, T882
E140-1	WTG-54VLW	6 x 3-13/16 x 3-1/8	M	BE	RH	
E141	WTG-B	5-1/4 x 4-5/8 x 3-1/4	P	BR	SR	T199, TP970, TP971, TP972, TP973, T26, T87, TS86, T832, T853, TP910
E142	WTG-EB	3-7/8 x 3-1/2 x 2-1/2	P	BR	S	
E142-1	WTG-EK	3-7/8 x 3-1/2 x 2-1/2	P	CL	S	
E142-2	WTG-EM	3-7/8 x 3-1/2 x 2-1/2	M	BE	S	
E142-3	WTG-EO	3-7/8 x 3-1/2 x 2-1/2	P	OP	S	
E143	WTG-K	5-1/4 x 4-5/8 x 3-1/4	P	CL	SR	

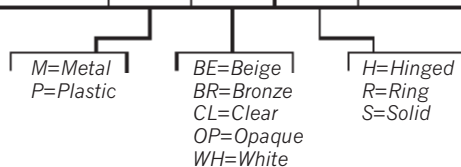

Please order by No.

THERMOSTAT GUARDS (CONTINUED)

METAL AND PLASTIC TAMPER PROOF DESIGNS IN PLEASING COLORS

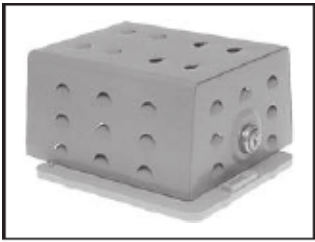

No. E143-1

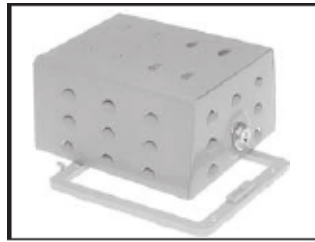

No. E143-2

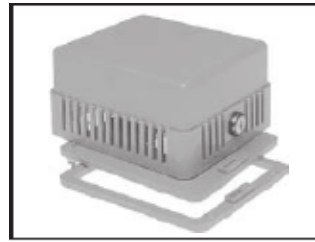

No. E143-3

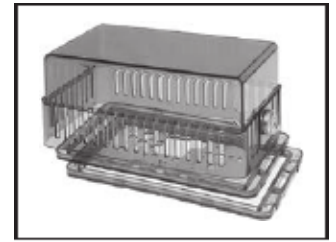

No. E144

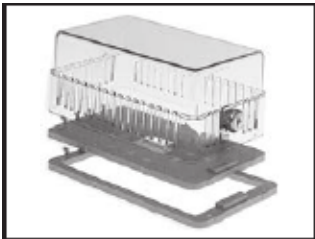

No. E144-1

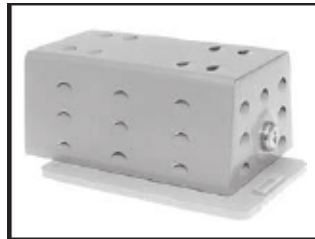

No. E144-2

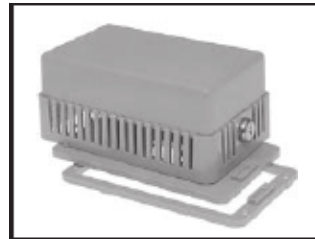

No. E144-3

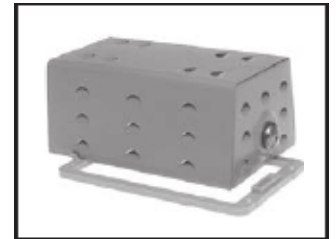

No. E144-4

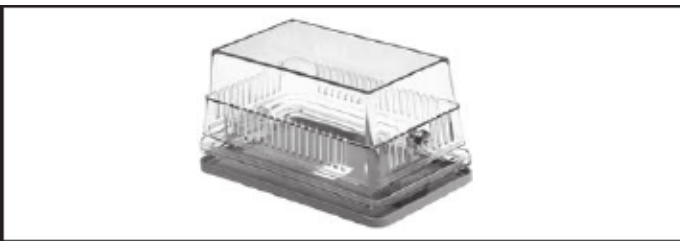

No. E145 Series

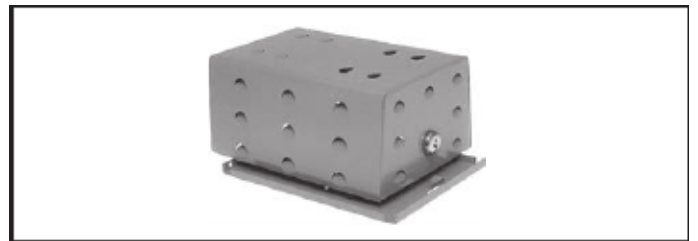

No. E146

No.	Ref. No.	Inside Dimensions H" x W" x D"	Mat'l	Color	Base	Comments
E143-1	WTG-KM	5-1/4 x 4-5/8 x 3	M	BE	S	
E143-2	WTG-KWM	5-1/4 x 4-5/8 x 3-1/4	M	BE	R	
E143-3	WTG-O	5-1/4 x 4-5/8 x 3-1/4	P	OP	SR	
E144	WTG-RB	6-3/8 x 3-1/2 x 3-1/4	P	BR	SR	
E144-1	WTG-RK	6-3/8 x 3-1/2 x 3-1/4	P	CL	SR	T80, T90, T91, T99, T199, T330, T340, T42, TA42, T26, TS86, T87, T92, T498, T651, T834, T921, T872, T882
E144-2	WTG-RM	6-3/8 x 3-1/2 x 3	M	BE	S	
E144-3	WTG-RO	6-3/8 x 3-1/2 x 3-1/4	P	OP	SR	
E144-4	WTG-RWM	6-3/8 x 3-1/2 x 3-1/4	M	BE	R	
E145	WTG-UB2	8-1/8 x 4-5/8 x 3-5/8	P	BR	SR	General, White-Rodgers, Barber Colman, Honeywell, Robertshaw, Camstat, Penn
E145-1	WTG-UK2	8-1/8 x 4-5/8 x 3-5/8	P	CL	SR	
E146	WTG-UM	7-1/4 x 5-3/8 x 3-1/2	M	BE	S	

M=Metal
 P=Plastic
 BE=Beige
 BR=Bronze
 CL=Clear
 OP=Opaque
 WH=White
 H=Hinged
 R=Ring
 S=Solid

THERMOSTAT GUARDS (CONTINUED)

METAL AND PLASTIC TAMPER PROOF DESIGNS IN PLEASING COLORS

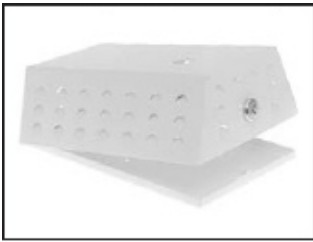

No. E147 Series



No. E148

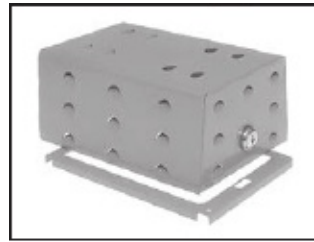

No. E149

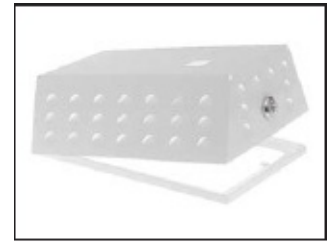

No. E150 Series



No. E151

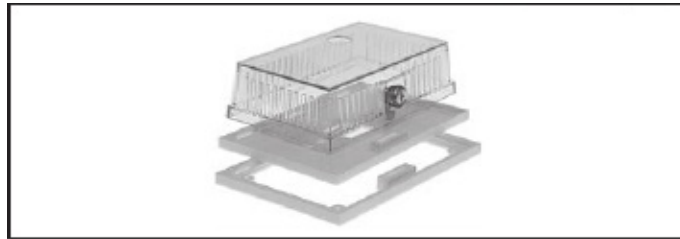

No. E151-1, -2



No. E151-3

No.	Ref. No.	Inside Dimensions H" x W" x D"	Mat'l	Color	Base	Comments
E147	WTG-UM1	9-3/8 x 6-3/4 x 3	M	WH	SH	Honeywell T7300 series
E147-1	WTG-UM1DH	9-3/8 x 6-3/4 x 3	M	WH	SH	Honeywell T7300 series w/display opening
E147-2	WTG-UM1DOH	9-3/8 x 6-3/4 x 3	M	WH	SH	Honeywell T7300 series w/override/display opening
E147-3	WTG-UM1DOWR	9-3/8 x 6-3/4 x 3	M	WH	SH	White-Rodgers IF90 series w/override/display opening
E147-4	WTG-UM1OH	9-3/8 x 6-3/4 x 3	M	WH	SH	Honeywell T7300 series w/override opening
E147-5	WTG-UM1SDH	9-3/8 x 6-3/4 x 3	M	WH	SH	Honeywell T7400 series w/display opening
E148	WTG-UO2	8-1/8 x 4-5/8 x 3-5/8	P	OP	SR	
E149	WTG-UWM	6-3/4 x 4-1/4 x 3-9/16	M	BE	R	
E150	WTG-UWM1	9-3/8 x 6-3/4 x 3	M	WH	RH	Honeywell T7300 series
E150-1	WTG-UWM1DH	9-3/8 x 6-3/4 x 3	M	WH	RH	Honeywell T7300 series w/display opening
E150-2	WTG-UWM1DOH	9-3/8 x 6-3/4 x 3	M	WH	RH	Honeywell T7300 series w/override/display opening
E150-3	WTG-UWM1DOWR	9-3/8 x 6-3/4 x 3	M	WH	RH	White-Rodgers IF90 series w/override/display opening
E150-4	WTG-UWM1OH	9-3/8 x 6-3/4 x 3	M	WH	RH	Honeywell T7300 series w/override opening
E150-5	WTG-UWM1SDH	9-3/8 x 6-3/4 x 3	M	WH	RH	Honeywell T7400 series w/display opening
E151	WTG-DB	4-1/8 x 7-1/16 x 2-1/4	P	BR	SR	
E151-1	WTG-DK	4-1/8 x 7-1/16 x 2-1/4	P	CL	SR	
E151-2	WTG-DK1	4-1/8 x 7-1/16 x 2-1/4	P	CL	SR	w/override opening
E151-3	WTG-DO	4-1/8 x 7-1/16 x 2-1/4	P	OP	SR	

M=Metal
 P=Plastic
 BE=Beige
 BR=Bronze
 CL=Clear
 OP=Opaque
 WH=White
 H=Hinged
 R=Ring
 S=Solid

Please order by No.

ULTRAGLO™ Thermostat Light

Mounts anywhere!

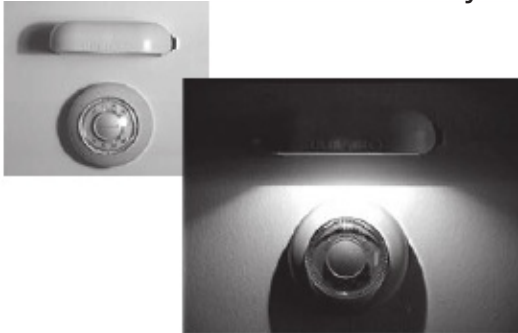

This easy to mount battery powered light has an ultra bright bulb that draws little current. It can be mounted in any convenient location with the two mounting screws provided. Easily slips out of its mounting bracket for use as a hand light. Use in cars, boats, RVs and campers too!

 No. **E140-40**

REPLACEMENT ZONE VALVE MOTOR

For motor driven OPEN, spring return CLOSE valves
(ie. Erie, Flare, Honeywell, Superior)

INSTALLS WITHOUT REMOVING VALVE FROM PIPING
USING EASY TO INSTALL EXTENDED BRASS SCREWS

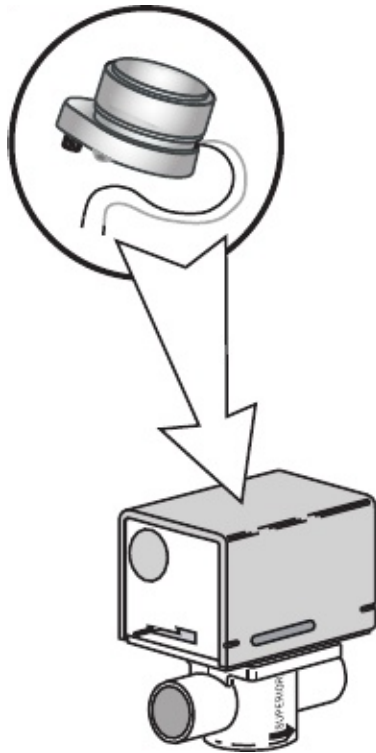

New easy to install screws!

 No.	Description
E180	<i>Individually packaged with installation instructions, wire nuts, and easy to install extended brass mounting screws</i> 24 VAC, 50/60 Hz, .32 A