

3-Phase voltage relay GRV8-03...08

Instruction Manual



General

■Applications

- Control for connection of moving equipment(site equipment, agricultural equipent,refrigerated trucks).
- Control for protection of persons and equipment against the consequences of reverse running.
- Normal/emergency power supply switching.
- Protection against the risk of a driving load(phase failure).

■Function Features

- Controls its own supply voltage(True RMS measurement).
- Set 8-level rated operating voltage through knob.
- Measuring frequency range:45Hz-65Hz.
- Voltage measurement accuracy<1%.
- Relay status is indicated by LED.
- 1-MODULE,DIN rail mounting.

■Model and connotation

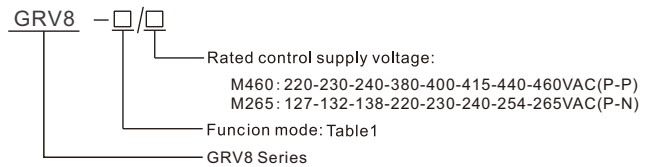

Panel Diagram

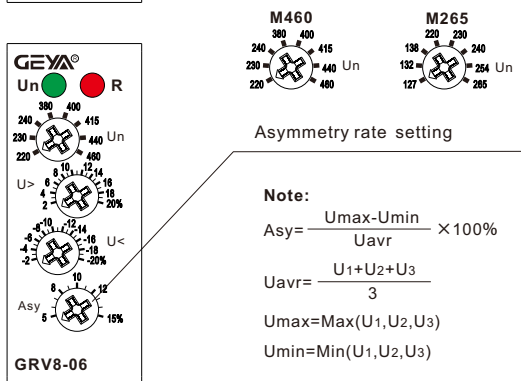
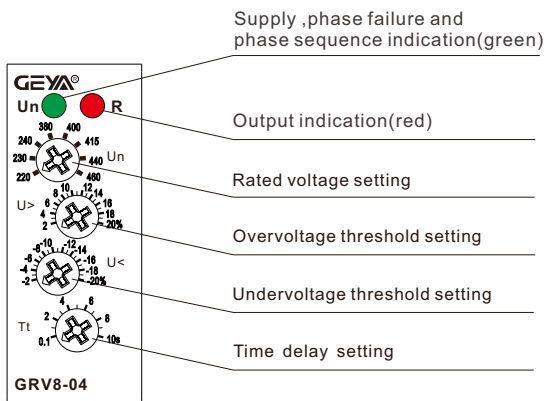

Table1

Function code	Over-voltage	Under-voltage	Asymmetry	Delay time	Phase sequence	Phase failure
03					●	●
04	2%...20%	-20%...2%		0.1s...10s	●	●
05	2%...20%	-20%...2%	8%	0.1s...10s	●	●
06	2%...20%	-20%...2%	5%...15%	2s	●	●
07			5%...15%	0.1s...10s	●	●
08	15%	-15%	8%	2s	●	●

Note:●the function is available

Technical parameters

Technical parameters	M460	M265
Function	Monitoring 3-phase voltage	
Monitoring terminals	L1-L2-L3	L1-L2-L3-N
Supply terminals	L1-L2	L1-N
Voltage range	220-230-240-380-400 -415-440-460(P-P)	127-132-138-220-230 -240-254-265(P-N)
Rated supply frequency	45Hz-65Hz	
Measuring range	176V-552V	101V-318V
Threshold adjustment voltage	2%-20%of Un selected	
Adjustment of asymmetry threshold	5%-15%	
Hysteresis	2%	
Phase failure value	70% of Un selected Min=165V	70% of Un selected
Time delay	Adjustable 0.1s-10s,10%	
Measurement error	≤1%	
Run up delay at power up	0.5s time delay	
Konb setting accuracy	10% of scale value	
Supply indication	green LED	
Output indication	red LED	
Reset time	1000ms	
Output	1×SPDT	
Current rating	10A/AC1	
Switching voltage	250VAC/24VDC	
Min.breaking capacity DC	500mW	
Temperature coefficient	0.05%/°C, at=20°C(0.05%/°F , at=68°F)	
Mechanical life	1×10 ⁷	
Electrical life(AC1)	1×10 ⁵	

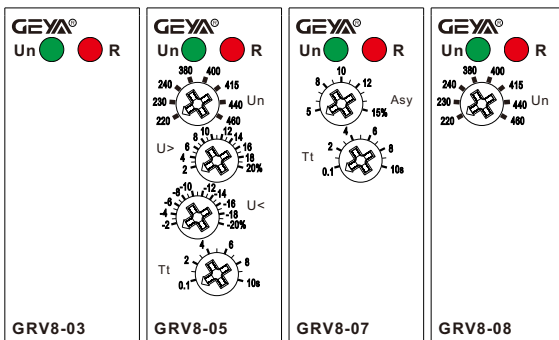

Functions Diagram

●Phase failure and phase equence function diagram

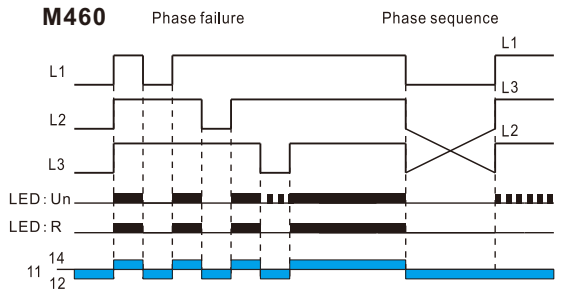

●Phase failure and phase equence function diagram

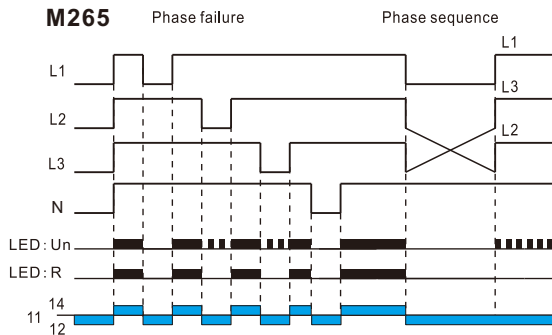

●Asymmetry function diagram

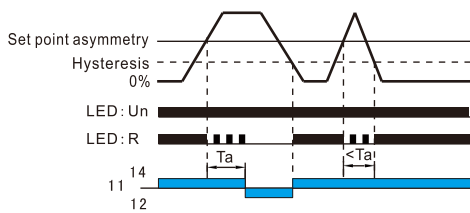

Operating temperature	-20°C to +55°C (-4°F to 131°F)
Storage temperature	-35°C to +75°C (-22°F to 158°F)
Mounting/DIN rail	Din rail EN/IEC 60715
Protection degree	IP40 for front panel/IP20 terminals
Operating position	any
Overvoltage category	III.
Pollution degree	2
Max.cable size(mm ²)	solid wire max.1X2.5or 2X1.5/with sleeve max.1X2.5(AWG 12)
Tightening torque	0.8Nm
Dimensions	90X18X64mm
Weight	61g-66g
Standards	EN 60255-1,IEC60947-5-1

●Overvoltage and undervoltage function diagram

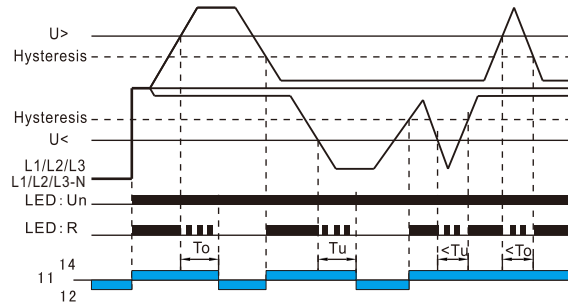

To:Overvoltage threshold tripping delay.

Tu:Undervoltage threshold tripping delay.

Ta:Asymmetry threshold tripping delay.

NOTE:

1. In case of phase fault at power supply terminals (M460:L1 and L2, M265:L1 and N), the function LED would not make indication.
2. If the Un switch position is changed while the device is operating, all the LEDs flash, but the product continues to operate normally with the voltage selected at the time of energisation preceding the change of position. The LED's return to their normal state if the switch is returned to the original position selected prior to the last energisation.

Dimensions(mm)

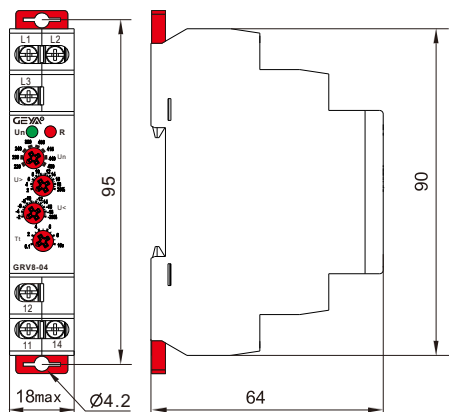

Wiring Diagram

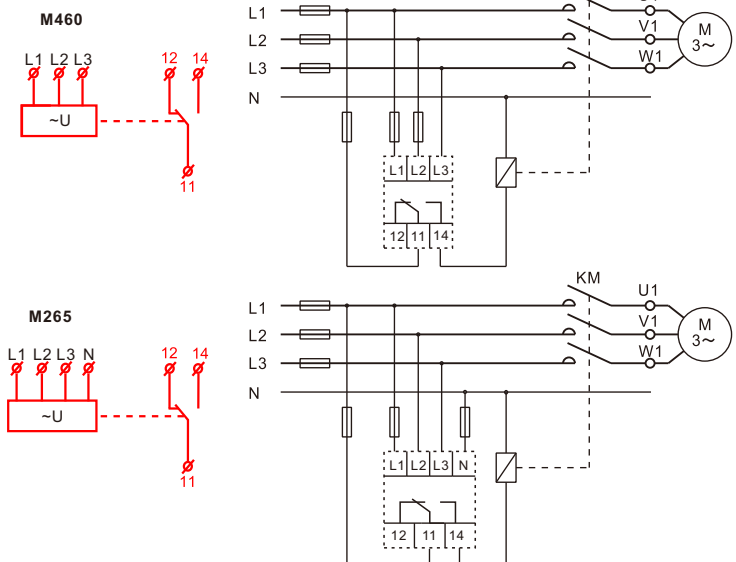

Disposal of Electrical Waste
All electrical waste should be disposed of in compliance with current WEEE regulations.



Caution

The products must be installed by qualified electricians. All and any electrical connections of the product shall comply with the appropriate safety standards.